

## Service Facts

### American Standard Link Variable Speed Heat Pumps and Air Conditioners

4A6V7X24A1000A  
4A6V7X36A1000A  
4A6V7X48A1000A  
4A6V7X60A1000A

4A7V7X24A1000A  
4A7V7X36A1000A  
4A7V7X48A1000A  
4A7V7X60A1000A

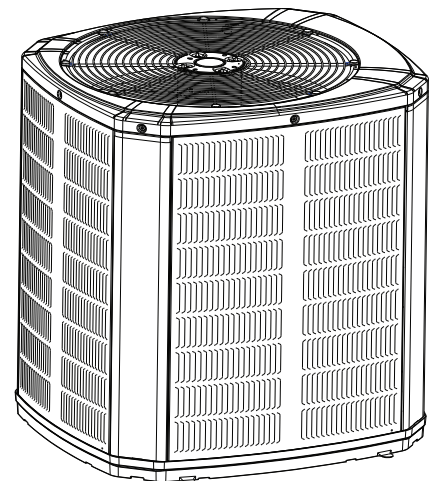

*Note: "Graphics in this document are for representation only. Actual model may differ in appearance."*



*The Diagnostics Mobile App is available by scanning a QR code located inside this unit or by searching for the Trane or American Standard Diagnostics App in your App Store®. This system must include a A/T HUI2360A200U thermostat and a TSYS2C60A2VVU system controller to operate and is Link communicating only.*

#### **⚠ SAFETY WARNING**

Only qualified personnel should install and service the equipment. The installation, starting up, and servicing of heating, ventilating, and air-conditioning equipment can be hazardous and requires specific knowledge and training. Improperly installed, adjusted or altered equipment by an unqualified person could result in death or serious injury. When working on the equipment, observe all precautions in the literature and on the tags, stickers, and labels that are attached to the equipment.

## SAFETY SECTION

**Important** — This document contains a wiring diagram and service information. This is customer property and is to remain with this unit. Please return to service information pack upon completion of work.

### **⚠ WARNING**

#### **HAZARDOUS VOLTAGE!**

Failure to follow this Warning could result in property damage, severe personal injury, or death.

Disconnect all electric power, including remote disconnects before servicing. Follow proper lockout/tagout procedures to ensure the power cannot be inadvertently energized.

### **⚠ WARNING**

#### **REFRIGERANT OIL!**

Any attempt to repair a central air conditioning product may result in property damage, severe personal injury, or death.

These units use R-410A refrigerant which operates at 50 to 70% higher pressures than R-22. Use only R-410A approved service equipment. Refrigerant cylinders are painted a "Rose" color to indicate the type of refrigerant and may contain a "dip" tube to allow for charging of liquid refrigerant into the system. All R-410A systems with variable speed compressors use a PVE oil that readily absorbs moisture from the atmosphere. To limit this "hygroscopic" action, the system should remain sealed whenever possible. If a system has been open to the atmosphere for more than 4 hours, the compressor oil must be replaced. Never break a vacuum with air and always change the driers when opening the system for component replacement.

### **⚠ CAUTION**

#### **HOT SURFACE!**

May cause minor to severe burning. Failure to follow this Caution could result in property damage or personal injury.

Do not touch top of compressor.

### **⚠ CAUTION**

#### **CONTAINS REFRIGERANT!**

Failure to follow proper procedures can result in personal illness or injury or severe equipment damage.

System contains oil and refrigerant under high pressure. Recover refrigerant to relieve pressure before opening system.

### **⚠ CAUTION**

#### **GROUNDING REQUIRED!**

Failure to inspect or use proper service tools may result in equipment damage or personal injury.

Reconnect all grounding devices. All parts of this product that are capable of conducting electrical current are grounded. If grounding wires, screws, straps, clips, nuts, or washers used to complete a path to ground are removed for service, they must be returned to their original position and properly fastened.

### **⚠ WARNING**

#### **SERVICE VALVES!**

Failure to follow this warning will result in abrupt release of system charge and may result in personal injury and/or property damage.

Extreme caution should be exercised when opening the Suction and Liquid Line Service Valve. Turn valve stem counterclockwise only until the stem contacts the rolled edge. No torque is required.

### **⚠ WARNING**

#### **BRAZING REQUIRED – IF USING MECHANICAL CONNECTIONS, ENSURE LEAK TEST IS NEGATIVE!**

Failure to inspect lines or use proper service tools may result in equipment damage or personal injury.

If using existing refrigerant lines make certain that all joints are brazed, not soldered.

### **⚠ WARNING**

#### **HIGH LEAKAGE CURRENT!**

Failure to follow this Warning could result in property damage, severe personal injury, or death.

Earth connection essential before connecting electrical supply.

⚠ **WARNING**

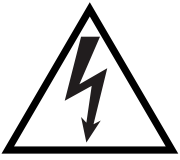

**400 VOLTS  
ELECTRICAL HAZARD**

Failure to follow this warning could result in personal injury or death.

WAIT TWO (2) MINUTES after disconnecting power prior to touching electrical components as they may hold a dangerous charge of 400VDC, then verify DC Voltage is less than 42 VDC at inverter test points labeled +DC and -DC before servicing board.



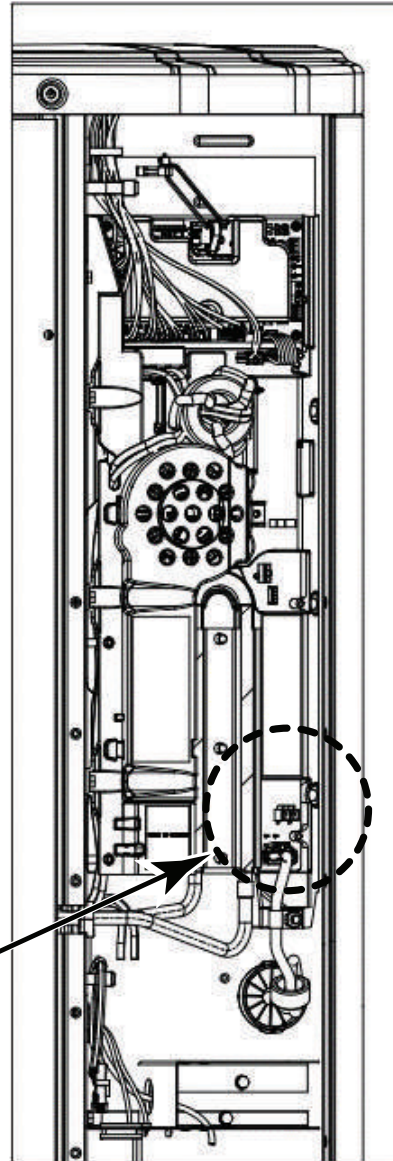

**Approved Combinations for Variable Speed Units running in American Standard Link mode**

- UX360 Smart Thermostat
- SC360 System Controller
- Approved System Accessories
- TAMX
- S8V2xxxxxVC

**Note:** See AHRI directory for approved indoor and outdoor model combinations. Only Trane / American Standard coils and air handlers are approved for use with variable speed outdoor unit.

**Important:** Use caution when cleaning outdoor coil to ensure no water enters the electrical control compartment. When cleaning coil from inside the compressor compartment, take special care not to spray water towards the top rows of the coil near the control panel. Water may enter the control compartment and drive damaging the electronics. Disconnect all electric power, including remote disconnects before servicing.

**Table 1. Operating Range**

Cooling	45° F to 120° F
Heating	-10° F to 66° F

# Product Specifications

## Heat Pump Models

<b>OUTDOOR UNIT</b> <sup>(a)</sup> <sup>(b)</sup>	4A6V7X24A1000A	4A6V7X36A1000A	4A6V7X48A1000A	4A6V7X60A1000A
POWER CONNS. — V/PH/HZ <sup>(c)</sup>	208/230/1/60	208/230/1/60	208/230/1/60	208/230/1/60
MIN. BRCH. CIR. AMPACITY	19.4	27.0	42.0	46.1
BR. CIR. PROT. RTG. — MAX. (AMPS)	25	30	45	50
<b>COMPRESSOR</b>	SCROLL	SCROLL	SCROLL	SCROLL
NO. USED — NO. SPEEDS	1-VARIABLE	1-VARIABLE	1-VARIABLE	1-VARIABLE
R.L. AMPS <sup>(d)</sup> — L.R. AMPS	11.5 — 10.2	18.1 — 10.2	20.3 — 12.0	27.5 — 12.0
<b>FACTORY INSTALLED</b>				
START COMPONENTS <sup>(e)</sup>	NA	NA	NA	NA
INSULATION/SOUND BLANKET	YES	YES	YES	YES
COMPRESSOR HEAT	YES	YES	YES	YES
<b>OUTDOOR FAN</b>				
DIA. (IN.) — NO. USED	23 — 1	23 — 1	27.5 — 1	27.5 — 1
TYPE DRIVE — NO. SPEEDS	DIRECT — VARIABLE	DIRECT — VARIABLE	DIRECT — VARIABLE	DIRECT — VARIABLE
CFM @ 0.0 IN. W.G. <sup>(f)</sup>	2680	2850	4467	4757
NO. MOTORS — HP	1 — 1/3	1 — 1/3	1 — 1/2	1 — 1/2
MOTOR SPEED R.P.M.	200 — 1200	200 — 1200	200 — 1200	200 — 1200
VOLTS/PH/HZ	208/230/1/60	208/230/1/60	208/230/1/60	208/230/1/60
F.L. AMPS	1.35	1.35	2.3	2.3
<b>OUTDOOR COIL — TYPE</b>	SPINE FIN™	SPINE FIN™	SPINE FIN™	SPINE FIN™
ROWS — F.P.I.	1 — 24	1 — 24	1 — 24	1 — 24
FACE AREA (SQ. FT.)	19.77	23.75	27.87	30.80
TUBE SIZE (IN.)	3/8	3/8	3/8	3/8
<b>REFRIGERANT</b>	R410-A	R410-A	R410-A	R410-A
LBS. — R-410A (O.D. UNIT) <sup>(g)</sup>	7 lb — 6 oz	8 lb — 13 oz	10 lb — 8 oz	13 lb — 2 oz
FACTORY SUPPLIED	YES	YES	YES	YES
RATED LINE SIZE — IN. O.D. GAS <sup>(h)</sup>	5/8	3/4	7/8	7/8
RATED LINE SIZE — IN. O.D. LIQ. <sup>(h)</sup>	3/8	3/8	3/8	3/8
<b>CHARGING SPECIFICATIONS</b>				
SUBCOOLING	10°	10°	10°	10°
<b>DIMENSIONS</b>	H X W X D	H X W X D	H X W X D	H X W X D
CRATED (IN.)	46 X 30 X 33	46 X 30 X 33	46 X 35 X 38	50 X 35 X 38
<b>WEIGHT</b>				
SHIPPING (LBS.)	225	238	268	285
NET (LBS.)	204	217	243	259

(a) Certified in accordance with the Air-Source Unitary Air-conditioner Equipment certification program, which is based on AHRI standard 210/240.

(b) Rated in accordance with AHRI standard 270/275.

(c) Calculated in accordance with Natl. Elec. Codes. Use only HACR circuit breakers or fuses.

(d) This value shown for compressor RLA on the unit nameplate and on this specification sheet is used to compute minimum branch circuit ampacity and max. fuse size. The value shown is the branch circuit selection current.

(e) NA means no start components. Yes means quick start kit components. PTC means positive temperature coefficient starter.

(f) Standard Air — Dry Coil — Outdoor

(g) This value approximate. For more precise value see unit nameplate.

(h) Max. linear length 150 ft.; Max. lift — Suction 50 ft.; Max. lift — Liquid 50 ft.

**Air Conditioner Models**

<b>OUTDOOR UNIT</b> <sup>(a) (b)</sup>	4A7V7X24A1000A	4A7V7X36A1000A	4A7V7X48A1000A	4A7V7X60A1000A
POWER CONNS. — V/PH/HZ <sup>(c)</sup>	208/230/1/60	208/230/1/60	208/230/1/60	208/230/1/60
MIN. BRCH. CIR. AMPACITY	19.4	27.0	42.0	46.1
BR. CIR. PROT. RTG. — MAX. (AMPS)	25	30	45	50
<b>COMPRESSOR</b>	SCROLL	SCROLL	SCROLL	SCROLL
NO. USED — NO. SPEEDS	1-VARIABLE	1-VARIABLE	1-VARIABLE	1-VARIABLE
R.L. AMPS <sup>(d)</sup> — L.R. AMPS	11.5 — 10.2	18.1 — 10.2	20.3 — 12.0	27.5 — 12.0
<b>FACTORY INSTALLED</b>				
START COMPONENTS <sup>(e)</sup>	NA	NA	NA	NA
INSULATION/SOUND BLANKET	YES	YES	YES	YES
COMPRESSOR HEAT	YES	YES	YES	YES
<b>OUTDOOR FAN</b>				
DIA. (IN.) — NO. USED	23 — 1	23 — 1	27.5 — 1	27.5 — 1
TYPE DRIVE — NO. SPEEDS	DIRECT — VARIABLE	DIRECT — VARIABLE	DIRECT — VARIABLE	DIRECT — VARIABLE
CFM @ 0.0 IN. W.G. <sup>(f)</sup>	2680	2850	4467	4757
NO. MOTORS — HP	1 — 1/3	1 — 1/3	1 — 1/2	1 — 1/2
MOTOR SPEED R.P.M.	200 — 1200	200 — 1200	200 — 1200	200 — 1200
VOLTS/PH/HZ	208/230/1/60	208/230/1/60	208/230/1/60	208/230/1/60
F.L. AMPS	1.35	1.35	2.3	2.3
<b>OUTDOOR COIL — TYPE</b>	SPINE FIN™	SPINE FIN™	SPINE FIN™	SPINE FIN™
ROWS — F.P.I.	1 — 24	1 — 24	1 — 24	1 — 24
FACE AREA (SQ. FT.)	19.77	23.75	27.87	30.80
TUBE SIZE (IN.)	3/8	3/8	3/8	3/8
<b>REFRIGERANT</b>	R410-A	R410-A	R410-A	R410-A
LBS. — R-410A (O.D. UNIT) <sup>(g)</sup>	7 lb — 6 oz	8 lb — 13 oz	10 lb — 8 oz	13 lb — 2 oz
FACTORY SUPPLIED	YES	YES	YES	YES
RATED LINE SIZE — IN. O.D. GAS <sup>(h)</sup>	5/8	3/4	7/8	7/8
RATED LINE SIZE — IN. O.D. LIQ.	3/8 <sup>(h)</sup>	3/8 <sup>(h)</sup>	3/8 <sup>(h)</sup>	3/8 <sup>(i)</sup>
<b>CHARGING SPECIFICATIONS</b>				
SUBCOOLING	10°	10°	10°	10°
<b>DIMENSIONS</b>	H X W X D	H X W X D	H X W X D	H X W X D
CRATED (IN.)	46 X 30 X 33	46 X 30 X 33	46 X 35 X 38	50 X 35 X 38
<b>WEIGHT</b>				
SHIPPING (LBS.)	225	238	268	285
NET (LBS.)	204	217	243	259

- (a) Certified in accordance with the Air-Source Unitary Air-conditioner Equipment certification program, which is based on AHRI standard 210/240.
- (b) Rated in accordance with AHRI standard 270/275.
- (c) Calculated in accordance with Natl. Elec. Codes. Use only HACR circuit breakers or fuses.
- (d) This value shown for compressor RLA on the unit nameplate and on this specification sheet is used to compute minimum branch circuit ampacity and max. fuse size. The value shown is the branch circuit selection current.
- (e) NA means no start components. Yes means quick start kit components. PTC means positive temperature coefficient starter.
- (f) Standard Air — Dry Coil — Outdoor
- (g) This value approximate. For more precise value see unit nameplate.
- (h) Max. linear length 150 ft.; Max. lift — Suction 50 ft.; Max. lift — Liquid 50 ft.
- (i) Max length of refrigerant lines from outdoor to indoor unit MUST NOT exceed 80 feet. The max vertical change MUST NOT exceed 25 feet. See footnote (h) if 7/8" suction line is used.

## Subcooling Charging in Cooling between 55° F and 120° OD Ambient

American Standard has always recommended installing American Standard approved matched indoor and outdoor systems.

The benefits of installing approved indoor and outdoor split systems are maximum efficiency, optimum performance and the best overall reliability.

The following charging methods are therefore prescribed for matched systems with indoor TXVs / EEVs.

1. Subcooling (in the cooling mode) is the only recommended method of charging between 55° and 120° ambient temperatures.
2. When charging for ambient temperatures above 120° or below 55°F, charge to 10° subcooling. It is important to return when outdoor ambient temperature is between 55° and 120° to verify system charge per these instructions.
3. For best results – the indoor temperature should be kept between 70° to 80°. Add system heat if needed.
4. Locate the designated subcooling target from the unit nameplate.
5. At startup, or whenever charge is removed or added, the system must be operated for a minimum of (20) minutes to stabilize before accurate measurements can be made.
6. Run the system using the “**Charging Mode-Cooling**” mode found in the UX360 User Interface and Diagnostic Mobile App. This is the only approved method for setting the system charge level.  
Measure Liquid Line Temperature and Refrigerant Pressure at service valves or monitor live data from the Monitor Menu in the Diagnostic Mobile App.
7. Determine total refrigerant line length, and height (lift) if indoor section is above the condenser. Follow the Subcool Charging Corrections Table to calculate additional subcooling target value.
8. Locate your liquid line temperature in the left column of the table, and the intersecting liquid line gage pressure under the subcool selection column. Add refrigerant to raise the pressure to match the table, or remove refrigerant to lower the pressure. Always wait (20) minutes for the system conditions to stabilize before adjusting charge again.
9. When system is correctly charged, you can refer to System Pressure Curves to verify typical performance.
10. American Standard Link systems have an American Standard Link Smart Charge feature available.

# Subcool Charging Correction Charts

**Note:** System will auto configure airflow in American Standard Link mode.

**Figure 1. Subcool Charging Corrections — 2.0 Ton**

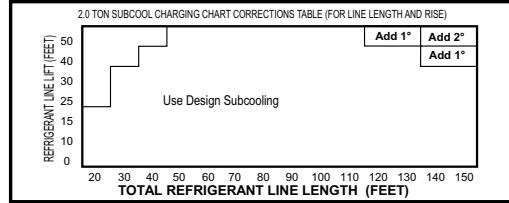

**Figure 2. Subcool Charging Corrections — 3.0 Ton**

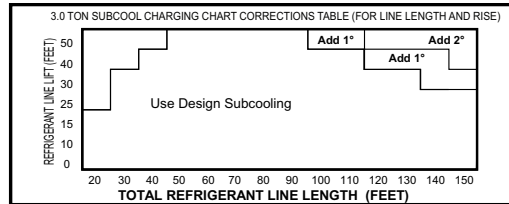

**Figure 3. Subcool Charging Corrections — 4.0 Ton**

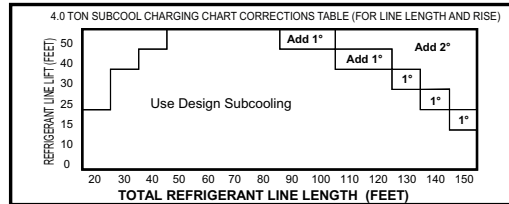

**Figure 4. Subcool Charging Corrections — 5.0 Ton**

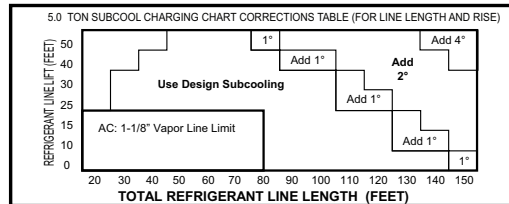

NOTE: 150 ft. length is approved ONLY with 7/8" vapor lines.

## Subcool Charging Correction Charts

### Refrigerant Charging Chart

R-410A REFRIGERANT CHARGING CHART							
LIQUID TEMP (°F)	DESIGN SUBCOOLING (°F)						
	8	9	10	11	12	13	14
	LIQUID GAGE PRESSURE (PSI)						
55	179	182	185	188	191	195	198
60	195	198	201	204	208	211	215
65	211	215	218	222	225	229	232
70	229	232	236	240	243	247	251
75	247	251	255	259	263	267	271
80	267	271	275	279	283	287	291
85	287	291	296	300	304	309	313
90	309	313	318	322	327	331	336
95	331	336	341	346	351	355	360
100	355	360	365	370	376	381	386
105	381	386	391	396	402	407	413
110	407	413	418	424	429	435	441
115	435	441	446	452	458	464	470
120	464	470	476	482	488	495	501
125	495	501	507	514	520	527	533

### Weigh-In Method for Charging

Weigh-In Method can be used for the initial installation, or anytime a system charge is being replaced. Weigh-In Method can also be used when power is not available to the equipment site or operating conditions (indoor/outdoor temperatures) are not in range to verify with the subcooling charging method.

Calculating Charge Using the Weigh-In Method		
<b>STEP 1</b> - Measure in feet the distance between the outdoor unit and the indoor unit. (Include the entire length of the line from the service valve to the IDU.) Subtract 10 ft from this entire length and record on line 1.	1. Total Line Length (ft) - 10 ft	
<b>STEP 2</b> - Enter the charge multiplier (0.6 oz/ft). Each linear foot of interconnecting tubing requires the addition of 0.6 oz of refrigerant.	2. Charge multiplier	x 0.6 oz
<b>STEP 3</b> - Multiply the total length of refrigerant tubing (Line 1) times the value on Step 2. Record the result on Line 3 of the Worksheet.	3. Step 1 x Step 2	= _____
<b>STEP 4</b> - This is the amount of refrigerant to weigh-in prior to opening the service valves.	4. Refrigerant (oz)	= _____oz

**Note:** The only mode approved for setting or validating system charge is using Charging Mode-Cooling. Charging Mode-Cooling is a variable speed test mode found in the UX360 User Interface and Diagnostic Mobile App. Outdoor Temperature must be between 55°F and 120°F with Indoor Temperature kept between 70°F and 80°F.

**Important:** Unit will auto-configure airflow in American Standard Link mode.





# Electrical – High Voltage

**Table 2. High Voltage Power Supply**

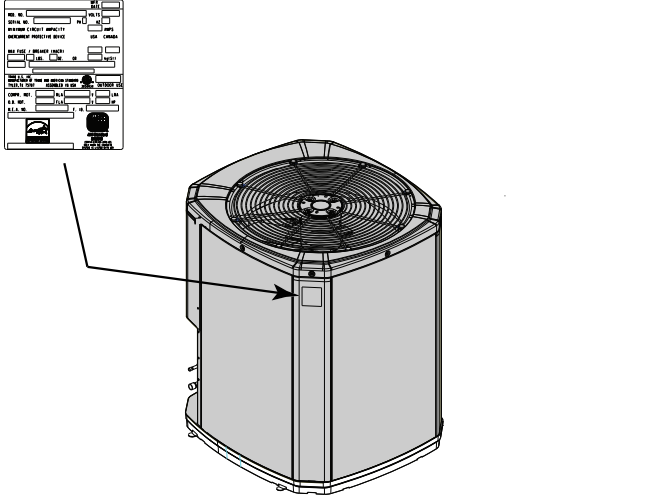
<p><b>⚠ WARNING</b> <b>LIVE ELECTRICAL COMPONENTS!</b> Failure to follow this Warning could result in property damage, severe personal injury, or death. Follow all electrical safety precautions when exposed to live electrical components. It may be necessary to work with live electrical components during installation, testing, servicing, and troubleshooting of this product.</p>	 <p>The diagram shows a high voltage power supply unit. On the left, a nameplate is visible with fields for 'SERIAL NO.', 'DATE OF MANUFACTURE', 'WARRANTY PERIOD', 'MODEL NO.', 'VOLTAGE', 'AMPERES', 'PHASES', 'FREQUENCY', 'WIRE GAUGE', 'CIRCUIT BREAKER', 'FUSE', 'TERMINALS', 'WIRING DIAGRAM', 'SERVICE FACTS', and 'INSTALLATION INSTRUCTIONS'. On the right, a fan is shown on top of the unit. An arrow points from the fan to the nameplate.</p>
<p>The high voltage power supply must agree with the equipment nameplate.</p> <p>Power wiring must comply with national, state, and local codes.</p> <p>Follow instructions on unit wiring diagram located on the inside of the control box cover and in the Service Facts document included with the unit.</p>	

**Table 3. High Voltage Disconnect Switch**

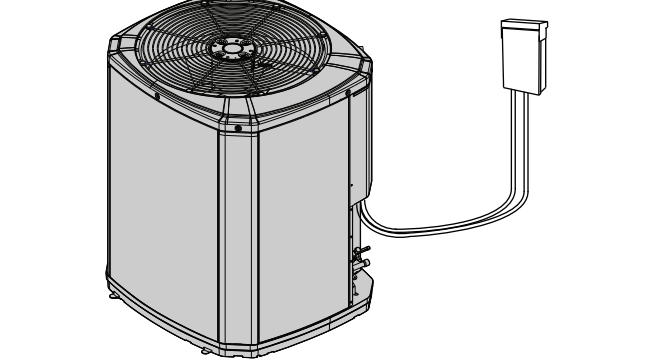
<p><b>⚠ WARNING</b> <b>HIGH LEAKAGE CURRENT!</b> Failure to follow this Warning could result in property damage, severe personal injury, or death. Earth connection essential before connecting electrical supply.</p>	 <p>The diagram shows a high voltage disconnect switch connected to a power supply unit. The switch is a rectangular box with a handle, connected to the unit by a cable. The unit is a cylindrical device with a fan on top.</p>
<p>Install a separate disconnect switch at the outdoor unit.</p> <p>For high voltage connections, flexible electrical conduit is recommended whenever vibration transmission may create a noise problem within the structure.</p>	

**Table 4. High Voltage Disconnect Switch**

<p>Ground the outdoor unit per national, state, and local code requirements.</p>	 <p>The diagram shows a grounding symbol, which consists of a vertical line connected to a horizontal line, with a small square at the end of the horizontal line.</p>
--	--

# Integrated Variable Speed Control Board LED Indicators

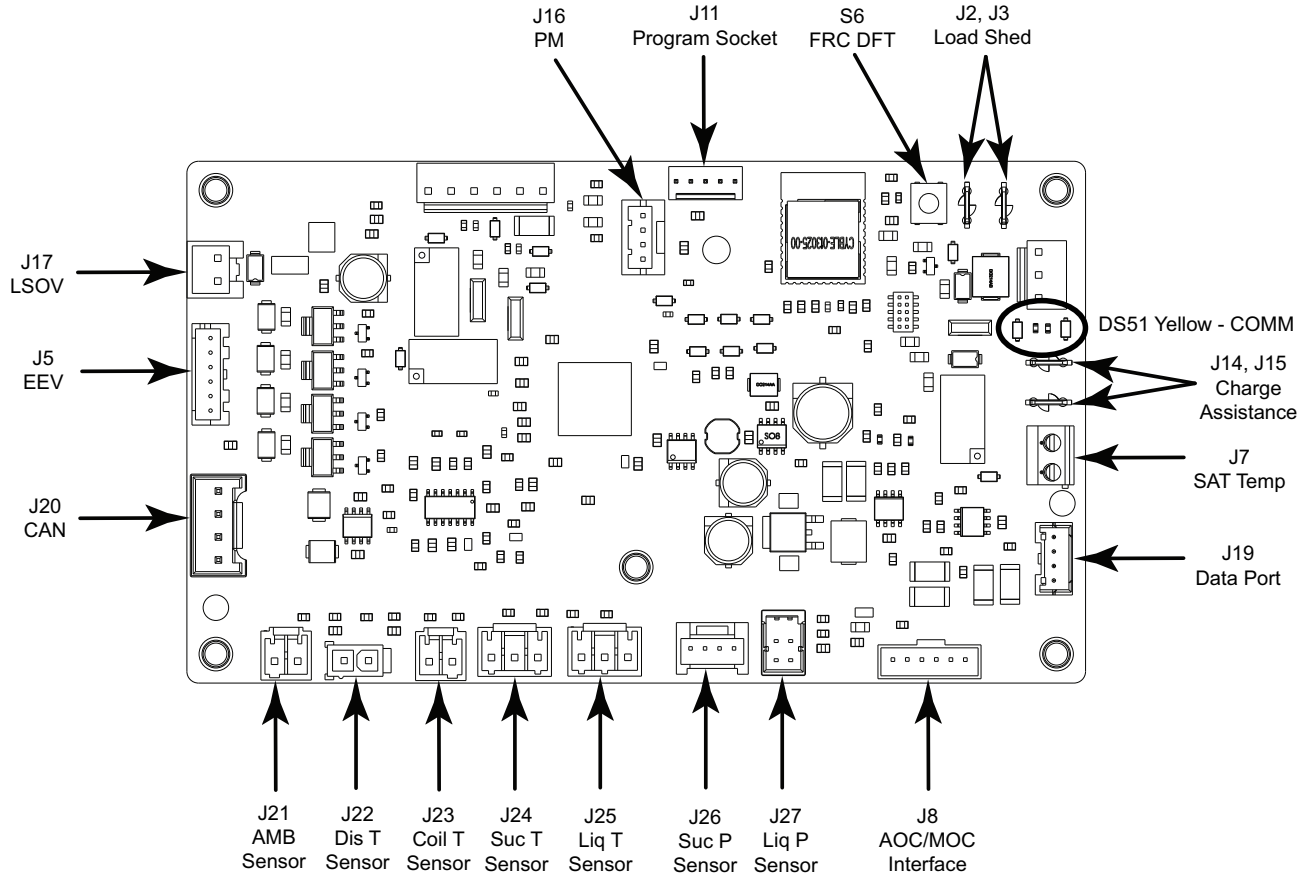

**Table 5. AOC LED flash codes**

LED	RATE	DESCRIPTION	INDICATION
COMM (AMBER)	SLOW	1 TIME PER DEVICE	DEVICE COUNT
	FAST	5 TIME PER SECOND	LOSS OF COMMUNICATION

**Table 6. MOC flash codes**

MOC STATUS		
LED	Color	Normal Operation
Status	Green	Constant On
Alarm	Red	Constant On when alarm active
Communication	Yellow	Blinks when sending data to AOC

Drive Diagnostic Result Alarm LED TABLE	
DRIVE TEST ALARM CODE	(FLASH COUNT, 2S DELAY REPEATED)
MOC FAULT OR HPS FAULT	KEEP FLASHING
INRUSH/PLC	1
COMPRESSOR OUTPUT SHORT CIRCUIT	2
COMPRESSOR OUTPUT OPEN CIRCUIT	3
COMPRESSOR OUTPUT CIRCUIT	4
FAN OUTPUT SHORT CIRCUIT	5
FAN OUTPUT OPEN CIRCUIT	6
FAN OUTPUT FAILURE	7

## Integrated Variable Speed Control Board LED Indicators

### Sump Heat Control

Sump Heat Control Guidelines	
Sump Heat ON	At power up; when outdoor temperature is below 85° F
	When outdoor temperature is below 80° F and compressor dome temperature is less than the outdoor ambient temperature
Sump Heat OFF	When the outdoor temperature goes above 85° F (Sump Heat remains OFF until outdoor temperature drops below 80° F)
	Anytime the compressor is running
	For 50 minutes after each compressor run cycle.
<p><b>Note:</b> Variable Speed systems are designed so that the compressor and sump heat will not run at the same time. Compressor windings are used for sump heat. When sump heat is active, line-side current will be approximately 1.5 amps. The CANda MONITOR MENU has a field for DRIVE &gt;&gt; DRIVE AMPS which can also be used to verify operation of sump heat.</p>	

# Sequence of Operation

## Control Operational Overview

Operation of the communicating, variable speed outdoor unit is managed and monitored by a micro processor based Control located in the control box of the outdoor unit. This component is also referred to as “The Drive”. Heat and Cool demand messages are transmitted from the SC360 system controller over the data lines from the system controller to the indoor and outdoor sections of the system. System mode and capacity requests are received by the outdoor control and responded to by providing control outputs to the switch-over valve (SOV) solenoid coil, electronic expansion valve (EEV) stepper motor, condenser fan motor and compressor. Operating conditions and system commands such as compressor percent demand, indoor airflow, EEV starting position, defrost (For auxiliary heat), outdoor temperature and alerts are transmitted from the outdoor control over the data lines to the SC360 system controller. Additional data that is communicated to the rest of the system includes the type of equipment installed (variable speed, unit size in nominal tonnage, heat pump or air conditioner) which is used during the Auto Discover function to configure the system controller for the equipment installed.

The AOC has one Light Emitting Diode (LED) used for indicating operating status and verifying communications. The COMM LED indicates successful communications by flashing a device count which can be used to verify how many communicating devices are connected to the data lines.

## Cooling Mode (A/C and Heat Pump)

When a request for cooling capacity is sent from the SC360 control to the outdoor unit, the SC360 control will calculate the required running speed for the compressor and outdoor fan based on the current capacity request sent from the SC360 control. Additionally, a CFM demand message is sent from the SC360 control to the indoor unit for matching indoor airflow.

Regardless of the requested capacity, the outdoor system will start and ramp to a target startup speed and hold steady for a minimum dwell period to ensure proper oil return. This dwell period will typically last for 1 minute but for initial start ups, after power is first applied, the dwell period is 15 minutes. The startup operation will progress to normal operation once this dwell period is completed. The system can duty cycle as needed to provide the required capacity requested from the SC360 control. The default duty cycle setting for stage one demand is 3 Cycles per Hour (CPH).

As capacity request value increases or decreases, so will the compressor, outdoor fan and indoor blower speeds to continuously deliver the capacity requested

by the control and meet the demand of the structural load. All indoor CFM demand messages will be sent from the SC360 System Controller to the indoor unit so that the blower motor will run with matching modulating speeds. The System Report Screens and Monitor menus are available in the UX360 User Interface and the Diagnostic Mobile App.

## Heat Pump Cooling Mode of Operation

In addition to stage and demand operating sequences outlined in the Cooling Mode description, when a heat pump system receives a demand message for cooling, the Switch Over Valve (SOV) solenoid will be pulsed to position the valve for cooling. Latching Switch Over Valve (LSOV) technology is standard with variable speed outdoor heat pumps. By utilizing components designed to hold the pilot pin of the SOV in place, the valve will maintain the cooling or heating position even when power is removed. Maintaining valve position, or Latching, is accomplished with the help of a magnet mounted in the solenoid coil or a spring manufactured internal to the SOV. To initiate the SOV position, a 12 Volt DC pulse is sent from the J17 plug located on the IVSC to the solenoid coil at the start of each call for capacity. Polarity of the DC pulse is critical to the direction the valve’s pilot pin will be set. Always follow the red and blue color coding to ensure proper polarity.

Heat pumps are also equipped with an Electronic Expansion Valve (EEV) which will be set to the “Check Valve Position” and drive wide open. The EEV does not provide refrigeration control in the cooling mode of operation.

## Heat Pump Heating Mode of Operation

In the heating mode, the LSOV will get a 4 Volt DC pulse to position the valve for heating at the start of each call for capacity.

During heating mode, the EEV will be in the controlling state. Refrigerant flow is managed by incrementally opening or closing the valve to control compressor superheat under a wide range of conditions. Superheat is calculated with feedback to the AOC from a suction line temperature sensor and a suction line pressure transducer. The AOC will target 10 degrees (+/-2) of superheat and drive a valve position by periodically pulsing the stepper motor and then monitoring compressor superheat results. Control signals to the EEV stepper motor are 12 volt DC pulses from J5 on the AOC. The EEV step position and compressor superheat can be monitored through the technician app monitor menu during runtime operation. The AOC will close the EEV with every OFF cycle and drive the valve to wide open during defrost or cooling mode of operation.

## Sequence of Operation

---

**Note:** *When a heat pump system is first powered up, the EEV produces an audible sound (soft ratcheting sound) as the valve drives to the closed position.*

### Heat Pump Heating Defrost Mode

When the system is operating in Heat Pump heating and the SC360 control initiates a Defrost, the SC360 control simultaneously:

- De-energizes the outdoor fan motor,
- Drives the OD EEV to full open and,
- Commands the SOV to change to the cooling mode.

There is a brief switchover time-delay (to allow refrigerant pressures to stabilize) before the compressor is commanded to run at Maximum Speed Cooling to perform Defrost.

The SC360 control also sends a demand message to the indoor unit to run the blower at Cooling mode

maximum speed (x2) and energize auxiliary heat (if equipped). Auxiliary heat blower speed may be higher than Cooling mode and will take precedence during defrost.

The Defrost Mode will be terminated after the OD coil temperature reaches 47°F or the maximum time override of 15 minutes has lapsed. At Defrost termination, the compressor will be commanded to go to the Defrost Switchover Speed. After that speed is achieved, the SOV position will be changed back to the heating mode of operation and the OD fan will be turned back on. Following the refrigerant stabilizing delay, the compressor will be allowed to run at any speed commanded by demand.

The AOC control will send the necessary pulse signals to the stepper motor coil returning the EEV to a controlling position that matches capacity demand and begin monitoring superheat.

# Defrost Control (Heat Pump only)

## Demand Defrost

The demand defrost control measures heat pump outdoor ambient temperature with a sensor located outside the outdoor coil. A second sensor located on the outdoor coil is used to measure the coil temperature. The difference between the ambient and the colder coil temperature is the difference or delta-T measurement. This delta-T measurement is representative of the operating state and relative capacity of the heat pump system. By measuring the change in delta-T, we can determine the need for defrost. The coil sensor also serves to sense outdoor coil temperature for termination of the defrost cycle.

## Fault Identification

A fault condition is announced at the UX360 thermostat and Diagnostic Mobile App.

## Defrost Enabled

Demand Defrost is enabled with the following inputs to the AOC:

- Outdoor ambient temperature sensor (ODS-B) reporting an outdoor temperature at or below 52° F.
- Coil temperature sensor (CBS) reporting a coil temperature at or below 35° F.
- Heat/Cool Demand (HCD) from the communicating comfort control for at least two minutes or more.

## Defrost Initiation

The calculated temperature difference between the outdoor temperature sensor and the coil temperature sensor is called Delta T. Defrost can occur once the current Delta T exceeds the Delta T initiate value. This adaptive logic assures a complete defrost for a range of outdoor temperatures.

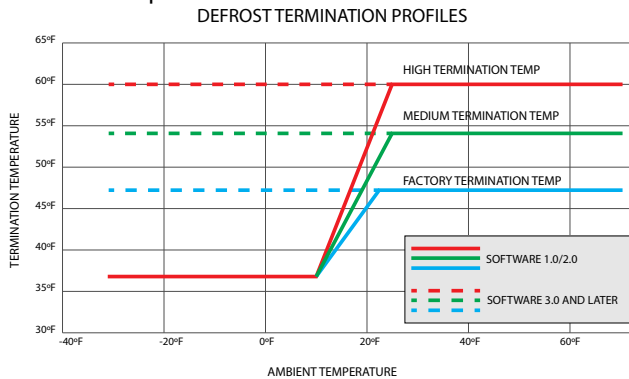

**Note:** A forced Defrost test can be entered through the UX360 thermostats, the outdoor unit AOC or the American Standard Link Diagnostic Mobile App.

## Forced Defrost

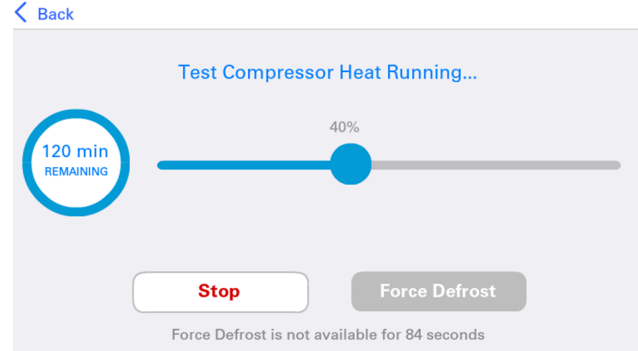

## NOTES: Forced Defrost

1. FRC DFT test can be run while in the heating mode by pressing the S6 button on the top right of the AOC. DFC TST can also be run while in the Compressor Heating test mode found in the UX360 or Diagnostic Mobile App.
2. Press ENTER to begin forced defrost.
3. Execute Forced Defrost following Forced Defrost (Defrost terminates on Coil Temperature or maximum time override of 15 minutes).
4. When test begins, the Diagnostic Mobile App monitor screens will update with coil temperatures and operation.

**Note:** UX360 Screen, under System Status will display DEFROST.

5. When test is complete, TEST COMPLETE displays for 10 seconds.
6. If there is a defrost fault condition, test terminates and sends alert to the alert menu in the UX360 and Diagnostic Mobile App.
7. For more information, refer to the Alert Code Tables in Service Facts and Technical Service Manual (Pub. No. 34-4301-01 or newer) documents.

**Note:** Monitor screens will update as the test proceeds.

**Note:** Can enter Forced Defrost from UX360, AOC or the Diagnostic Mobile App.

# SENSORS

## J22 Compressor Dome Temperature

This table shows the corresponding voltage, resistance and temperature readings for the Dome Temperature Sensor when measured across pins J22. The power source for the Dome Temperature Sensor is 3.2VDC.

TEMP F	TEMP C	THERMISTOR RESISTANCE (OHMS)	VOLTS DC (PIN TO PIN)
-15	-26.11	139453	3.13
-10	-23.33	118062	3.11
-5	-20.56	100258	3.10
0	-17.78	85393	3.08
5	-15.00	72944	3.06
10	-12.22	62487	3.04
15	-9.44	53676	3.02
20	-6.67	46232	2.99
25	-3.89	39925	2.96
30	-1.11	34567	2.93
35	1.67	30003	2.89
40	4.44	26105	2.85
45	7.22	22767	2.80
50	10.00	19903	2.75
55	12.78	17438	2.70
60	15.56	15312	2.64
65	18.33	13475	2.58
70	21.11	11883	2.51
75	23.89	10501	2.45
80	26.67	9298	2.37
85	29.44	8249	2.30
90	32.22	7333	2.22
95	35.00	6530	2.14
100	37.78	5826	2.06
105	40.56	5208	1.97
110	43.33	4663	1.89
115	46.11	4182	1.80
120	48.89	3758	1.72
125	51.67	3382	1.63
130	54.44	3048	1.55
135	57.22	2752	1.47
140	60.00	2488	1.39
145	62.78	2253	1.31
150	65.56	2043	1.24
155	68.33	1856	1.17
160	71.11	1688	1.10
165	73.89	1537	1.03
170	76.67	1402	0.97
175	79.44	1280	0.91
180	82.22	1170	0.85
185	85.00	1071	0.80

TEMP F	TEMP C	THERMISTOR RESISTANCE (OHMS)	VOLTS DC (PIN TO PIN)
190	87.78	982	0.74
195	90.56	901	0.70
200	93.33	828	0.65
205	96.11	762	0.61
210	98.89	702	0.57
215	101.67	647	0.53
220	104.44	597	0.50
225	107.22	552	0.47
230	110.00	511	0.44
235	112.78	473	0.41
240	115.56	438	0.38
245	118.33	407	0.36
250	121.11	378	0.33
255	123.89	351	0.31
260	126.67	327	0.29
265	129.44	304	0.27
270	132.22	284	0.26
275	135.00	265	0.24
280	137.78	247	0.23
285	140.56	231	0.21
290	143.33	216	0.20
295	146.11	203	0.19
300	148.89	190	0.18
305	151.67	178	0.17
310	154.44	167	0.16
315	157.22	157	0.15
320	160.00	148	0.14
325	162.78	139	0.13
330	165.56	131	0.12

A working Compressor Dome Temperature Sensor is required for:

- Protection (High/Low Temperature)
- Preheating (Sump Heat)
- Outdoor EEV Control
- Diagnostics; Reverse rotation, Flooding, Charge Level

The Dome Temperature Sensor control contains an NTC thermistor input for sensing the Compressor Dome Temperature. The thermistor has a nominal resistance of  $\approx 10k$  ohms at 75°F. The minimum range required for the Dome Temperature input is  $-31^{\circ}\text{F}$  to  $302^{\circ}\text{F}$ . when measured across pins J22.

**Note:** Secure Installation of Dome Sensor is required for reliable compressor & system operation.



## J21 Ambient Temperature Sensor (ODS)

These tables show the corresponding voltage, resistance and temperature readings for the Ambient, Temperature Sensor when measured across pins 5 & 14.

The power source for the Ambient, Coil and Suction Temperature sensors is 3.2VDC

TEMP F	TEMP C	THERMISTOR RESISTANCE (OHMS)	VOLTS DC
-15	-26.11	135976	2.43
-10	-23.33	115112	2.33
-5	-20.56	97745	2.22
0	-17.78	83247	2.11
5	-15.00	71108	1.99
10	-12.22	60916	1.87
15	-9.44	52334	1.75
20	-6.67	45088	1.63
25	-3.89	38952	1.52
30	-1.11	33742	1.40
35	1.67	29307	1.29
40	4.44	25520	1.19
45	7.22	22280	1.09
50	10.00	19499	1.00
55	12.78	17108	0.91
60	15.56	15045	0.83
65	18.33	13262	0.75
70	21.11	11717	0.68
75	23.89	10375	0.62
80	26.67	9207	0.56
85	29.44	8188	0.51
90	32.22	7297	0.46
95	35.00	6516	0.42
100	37.78	5830	0.38
105	40.56	5227	0.35
110	43.33	4695	0.31
115	46.11	4224	0.29
120	48.89	3808	0.26
125	51.67	3439	0.24
130	54.44	3111	0.21
135	57.22	2820	0.20
140	60.00	2559	0.18

The Ambient Temperature Sensor control has an NTC thermistor input for sensing the outdoor air temperature and has a nominal resistance of  $\approx 10k$  ohms at 75°F. The Ambient Temperature is measured on J21 header. The minimum range required for the Ambient Temperature Sensor is  $-40^{\circ}\text{F}$  to  $140^{\circ}\text{F}$ .

A working Ambient Temperature Sensor is required for the following:

- Low Pressure Monitoring
- Defrost (Heat Pump)
- Comfort Control Display (Outdoor Air Temperature)
- Aux Heat Control During Defrost (Heat Pump)
- Aux Heat Lockout
- Compressor Lockout (Heat Pump)
- Oil Management
- Humidifier Dew-Point Control
- OD EEV Startup Position
- ID EEV Startup Position
- Pre Heating (Sump Heat)
- Normal Operation of the ID and OD Fan
- Diagnostics

**SENSORS**

**J24 Coil, Suction and Liquid Temperature Sensor**

TEMP F	TEMP C	THERMISTOR RESISTANCE (OHMS)	VOLTS DC
-15	-26.11	135976	2.71
-10	-23.33	115112	2.64
-5	-20.56	97745	2.56
0	-17.78	83247	2.48
5	-15.00	71108	2.38
10	-12.22	60916	2.29
15	-9.44	52334	2.19
20	-6.67	45088	2.08
25	-3.89	38952	1.97
30	-1.11	33742	1.86
35	1.67	29307	1.75
40	4.44	25520	1.64
45	7.22	22280	1.53
50	10.00	19499	1.42
55	12.78	17108	1.32
60	15.56	15045	1.22
65	18.33	13262	1.13
70	21.11	11717	1.04
75	23.89	10375	0.96
80	26.67	9207	0.88
85	29.44	8188	0.81
90	32.22	7297	0.74
95	35.00	6516	0.68
100	37.78	5830	0.62
105	40.56	5227	0.57
110	43.33	4695	0.52
115	46.11	4224	0.47
120	48.89	3808	0.43
125	51.67	3439	0.40
130	54.44	3111	0.36
135	57.22	2820	0.33
140	60.00	2559	0.30

The Coil Temperature Sensor control has an NTC thermistor input for sensing the coil temperature. This reading is used by the defrost algorithm on heat pump units. The thermistor has a nominal resistance of 10k ohms at 75°F. The minimum range and resolutions as measured across the J23 header required for Coil Temperature Sensor is –50°F to 150°F.

A working Coil Temperature Sensor is required for the following:

- Defrost Initiation and Termination
- Compressor Sump Heat (Preheating)
- Diagnostics; Charge Level, Indoor/Outdoor Airflow

The Suction Temperature Sensor control utilizes an NTC thermistor input for sensing the suction/gas temperature. The thermistor has a nominal resistance of ≈ 10k ohms at 75°F. The minimum range and resolutions as measured across J24 required for the Suction Temperature Sensor is –50°F to 150°F.

A working Suction Temperature Sensor is required for:

- Outdoor EEV Control (Target Super Heat)
- Diagnostics; Charge level, Indoor/Outdoor Airflow

The Liquid Temperature Sensor control utilizes an NTC thermistor input for sensing the liquid temperature. The thermistor has a nominal resistance of ≈ 10k ohms at 75°F. The minimum range and resolutions as measured across J25 header required for the Liquid Temperature Sensor is –50°F to 150°F.

A working Liquid Temperature Sensor is required for:

- American Standard Link Smart Charge
- Diagnostics; Charge level

## J27 Liquid Line Pressure Transducer

This table shows the corresponding voltage and pressure readings for the Liquid Line Pressure Transducer when measured across J27 header.

<b>PRESSURE (PSIG)</b>	<b>VOLTS DC PIN 16 TO PIN 17</b>
30	0.66
60	0.83
90	1.00
120	1.18
150	1.35
180	1.52
210	1.69
240	1.86
270	2.03
300	2.21
330	2.38
360	2.55
390	2.72
420	2.89
450	3.06
480	3.23
510	3.41
540	3.58
570	3.75
600	3.92
630	4.09
660	4.26

A working Liquid Pressure Transducer is required for the following:

- American Standard Link Smart Charge
- Diagnostics; Charge Level

The Liquid Pressure Transducer control is measured across J27 White and Black and has an active 0–4.9VDC transducer input for sensing high liquid pressure.

<b>DESCRIPTION</b>	<b>LOCATION</b>	<b>WIRE COLOR</b>
4.9 VDC POWER	J27 Header	RED
OUTPUT		WHITE
COMMON		BLACK
GROUND		GREEN

**SENSORS**

**J26 Suction Line Pressure Transducer**

This table shows the corresponding voltage and pressure readings for the Suction Line Pressure Transducer when measured across J26.

<b>PRESSURE (PSIG)</b>	<b>VOLTS DC PIN 7 TO PIN 8</b>
10	0.60
20	0.70
31	0.81
41	0.91
51	1.00
60	1.10
70	1.20
82	1.32
92	1.42
101	1.52
111	1.62
120	1.72
130	1.81
140	1.91
152	2.03
161	2.13
171	2.23
181	2.33
190	2.43
200	2.52

A working Suction Pressure Sensor is required for the following:

- Start Up (Pressure Limits)
- Low Pressure, Loss of Charge Protection
- Indoor Coil Freeze Protection
- Outdoor EEV Control (Target Super Heat)
- Diagnostics; Reverse Rotation, Charge Level, Indoor/Outdoor Airflow

The Suction Pressure Transducer control is measured across J26 White & Black and has an active 0–4.9VDC transducer input for sensing low suction pressure.

<b>DESCRIPTION</b>	<b>LOCATION</b>	<b>WIRE COLOR</b>
4.9 VDC POWER	J26 Header	RED
OUTPUT		WHITE
COMMON		BLACK
GROUND		GREEN

## Variable Speed Alert Codes

Alert Code	Alert Group	Display Assembly Text	Sub-alarm	State action on occurrence	State action on clearance	Alert Description	Possible Cause
18	Control Failure	CTRL FLT	4	Shutdown. Send Err code to thermostat and Fault text to CANda	Resume normal operation.	Internal control error is detected	Control failure, replace IVSC Or MOC. Contact technical support
67	Temp Sensor Fault	AMB T SENSE	0	For Cooling mode, "Assume Ambient Temp" as per Limp along mode and Continue normal operation. For Heating mode, go to timed defrost.	With actual ambient temperature, continue normal operation. For Heating mode, follow demand defrost algorithm	Ambient Temperature Sensor alert	Ambient Sensor out-of-range (Open/Shorted/Missing)
		COIL T SENSE	1	For Cooling mode, continue normal operation. For heating mode, go to timed defrost.	For Cooling mode, continue normal operation. For heating mode, go to timed defrost.	Coil Temperature Sensor alert	Coil Sensor out-of-range (Open/Shorted/Missing)
		LIQ T SENSE	2	Unit will not report Liquid Temp to diagnostics or tech app. Smart Charge will not be able to run.	Resume normal operation when fault no longer exists	OD Liquid temperature sensor fault	Damaged sensor or not installed
		EXT T SENSE	3	Cooling - Normal operation	Continue normal operation	External Temperature Sensor alert	Ext Sensor out-of-range (Shorted) Open/Missing revert to Ambient Sensor input
		DOM E T SENSE	4	Cooling - Normal operation	Continue normal operation	Discharge Temperature Sensor is faulted in Cooling mode	Discharge Sensor out-of-range (Open/Shorted/Missing)
		DOM E T SENSE	5	Heating - Limp along mode of constant speed (compressor speed is limited to 2400 RPM)	Ramp up to demand speed and resume normal operation.	Discharge Temperature Sensor is faulted in Heating mode	Discharge Sensor out-of-range (Open/Shorted/Missing)
		SUCT T SENSE	6	Cooling - Normal operation	Continue normal operation	Suction Temperature Sensor is faulted in Cooling mode	Suction Sensor out-of-range (Open/Shorted/Missing)
		SUCT T SENSE	7	Heating - Limp along mode of constant speed (Compressor speed is limited to 2400 RPM, EEV is locked to safe position)	Ramp up to demand speed and resume normal operation.	Suction Temperature Sensor is faulted in Heating mode	Suction Sensor out-of-range (Open/Shorted/Missing)
		CDT UNATCHD	8	Heating - Limp along mode of constant speed (compressor speed is limited to 2400 RPM)	Ramp up to demand speed and resume normal operation.	Compressor Discharge Temperature Sensor not attached to Compressor (Heating Mode)	Compressor Discharge Temperature Sensor not attached to Compressor (Heating Mode) Introduced with AOCS software Version 2, Fall of 2014)
68	Defrost Fault	DFT FAULT A	0	As defined in Defrost algorithm	Continue normal operation	Defrost Fault A has been detected	Low heat pump capacity (Inoperative compressor, loss of charge, shorted coil sensor, open ambient sensor)
		DFT FAULT B/C	1	As defined in Defrost algorithm	Continue normal operation	Defrost Fault B or C has been detected	Fault B indicates 10 defrosts terminated on time override. Fault C indicates sensor High Delta T.
		DFT FAULT A(B/C)	2	As defined in Defrost algorithm	Continue normal operation	Defrost Fault A and B or A and C have been detected	Within a given length of time, both faults existed

**Variable Speed Alert Codes**

Alert Code	Alert Group	Display Assembly Text	Sub-alarm	State action on occurrence	State action on clearance	Alert Description	Possible Cause
80	High Pressure Monitor Fault	HP SHORT LO	0	5 min of compressor lockout and send "WAIT" to thermostat	Restart with reduced capacity. (Capacity reduced by 1/5 with each occurrence)	High pressure switch has tripped resulting in a High Pressure Short Lock Out.	Overcharged. <b>Cooling Mode:</b> Outdoor Fan Failure, clogged coil, recirculation, excessive high ambient, non condensable. <b>Heating Mode:</b> Indoor Fan Failure, clogged coil, non condensable.
		HP HARD LO	1	Lockout compressor operation until power cycle, No system operation	Can be cleared only on power cycle. After power cycle, the compressor shall resume normal operation.	6 High Pressure Short Lock Out events have occurred resulting in a High Pressure Hard Lock Out. (High Pressure Limit = 650psig)	Overcharged. <b>Cooling Mode:</b> Outdoor Fan Failure, clogged coil, recirculation, excessive high ambient, non condensable. <b>Heating Mode:</b> Indoor Fan Failure, clogged coil, non condensable.
		HP RED RPS	2	On restart, after short lockout, compressor will operate at reduced capacity and this alert is declared. (Message on Tstat informing of reduced capacity) Note: Recover reduced capacity with each 2 hr run time window without an HPCO trip.	Normal operation resumes.	High Pressure trip point has been exceeded and a 5 minute time out has been enforced. Restart is allowed but with reduced capacity.	Overcharged. <b>Cooling Mode:</b> Outdoor Fan Failure, clogged coil, recirculation, excessive high ambient, non condensable. <b>Heating Mode:</b> Indoor Fan Failure, clogged coil, non condensable.
88	Ground fault	GND FAULT LO	1	Emergency shutdown. Drive will protect itself.	Can be cleared only on power cycle. After power cycle, the compressor shall resume normal operation.	Grounding issue from output of the drive. If the sum of all three currents exceeds 10 amp to ground	Burnt winding, faulty current sensor, internal board short, pinched compressor lead (shorted). Run Drive Test. (GoTo "Compressor Verification" troubleshooting flow chart)
91	Communication Fault	SYS COM ERR	2	Shutdown if Heat/Cool demand message not received for 3 reporting intervals.	Resume normal operation	Loss of Heat/Cool demand message	Open/Shorted Data line Check for reversed polarity
		NO SYS CLK	3	Shutdown	Resume normal operation	Loss of Bit Master	Bit Master Control Fault
94	System Communication Error	SYS COMM ERR	0	Shutdown	Resume normal operation	Master detects slave(s) missing, user checks equipment table to find out what devices are missing we would like to know what devices are missing - consider for future implementation. This alert to be reported for missing status on following slave devices only 1. ID AHC 2. OD AOC	ID unit or OD unit is powered down Check for loose/ bad connection between ID and OD unit and System Controller
106	External Shutdown Fault	OD EXT SW OPEN	1	Compressor cooling operation shall not be allowed.	Resume normal operation. Cooling operation allowed.	External shutdown switch is Active and input at T3 to T4 or J2 to J3 is open	External Load Shed device is active with external switch configured to Active and input at T3 to T4 or J2 to J3 is open

## Variable Speed Alert Codes

Alert Code	Alert Group	Display Assembly Text	Sub-alarm	State action on occurrence	State action on clearance	Alert Description	Possible Cause
106	Indoor External Switch Has Been Activated	ID EXT SW2 OPEN	0			The External Switch configuration has been enabled and external switch contacts are open at the indoor unit	
106	Indoor External Switch #2 Has Been Activated	ID	0			Indoor External Switch #2 Has Been Activated	
113	Protection Fault	LIQ P SENSE	0	Unit will not report Liquid pressure to diagnostics or tech app. Smart Charge will not be able to run	Resume normal operation when fault no longer exists	OD liquid pressure sensor fault	Damaged Transducer open/ short. Should have 5vdc supply voltage to transducer.
114	Bad or Missing PM	PM DATA ERR	0	Continue normal operation	Continue normal operation	PM data corrupt	PM Error
		PM MISSING	3	Continue normal operation	Continue normal operation	PM missing with good local copy	PM Error
		PM UNIT ERR	4	Continue normal operation	Continue normal operation	Bad data in PM with good local copy	PM error
114	Bad or Missing PM	PM MEM ERR	5	Shutdown. No compressor operation until a good PM is inserted.	Resume normal operation	Bad data in PM with no local copy	PM Error
		PM MISSING	6	Shutdown. No compressor operation until a good PM is inserted.	Resume normal operation	PM bad or missing with no local copy	PM Error
155	OD EEV Motor Fault	EEV MTR ERR	2	Can not run in Heating mode, Can run in Cooling mode	Power cycle	The OD EEV electric coil has an open or intermittent short circuit.	EEV motor coil open or shorted
		OD EEV DIAG ER	3	Limp Mode	EEV operates for PM steps continuously	Diagnostic current or voltage valves are not in range	EEV motor coil open or shorted
156	System Low Charge Fault	LOW CHARGE	1	High Superheat occurrences	Superheat Change occurs and allows control within the EEV range of operation. (Superheat target is 10 degrees +/- 4)	High Superheat occurrence of 35 degrees or more has been detected for more than 60 minutes.	System low charge, liquid line restriction, sensor calibration
159	Unit Bus Fault	IPC3 COM ERR	5	OD Continue normal operation	Continue normal operation. Technician interface available	Display Assembly communication error	Wire assembly between Display Assembly and IVSC board
164	Outdoor EEV Valve Migrated Open	EEV OPEN ERR	2	The valve is not responding to a change in position, EEV supposedly opened fully and no change to accommodate superheat occurred.	Superheat Change occurs and allows control within the EEV range of operation	EEV migrated to open position but superheat is not at the desired set point. Valve is not responding to a change in position.	Possible stuck valve or sensor(s) out of calibration
	Outdoor EEV Valve Migrated Closed	EEV CLSE ERR	3	The valve is not responding to a change in position, EEV supposedly closed fully and no change to accommodate superheat occurred.	Superheat Change occurs and allows control within the EEV range of operation	EEV migrated to closed position but superheat is not at the desired set point. Valve is not responding to a change in position.	Possible stuck valve or sensor(s) out of calibration
165	Low Superheat Error	LO SUPERHEAT	1	Low Superheat occurrences	Superheat Change occurs and allows control within the EEV range of operation	Low super heat (less than 3 degrees) has been detected for more than 60 minutes	Possible stuck valve, sensor(s) out of calibration, low airflow, overcharge, check valve leaking.
166	Low Superheat Error	LO SUPERHEAT	1	Low Superheat with EEV closed	Superheat Change occurs and allows control within the EEV range of operation	EEV valve closed and still flooding	Possible stuck valve, sensor(s) out of calibration, low airflow, overcharge, check valve leaking.

**Variable Speed Alert Codes**

Alert Code	Alert Group	Display Assembly Text	Sub-alarm	State action on occurrence	State action on clearance	Alert Description	Possible Cause
172	Key fault	KEY FAULT	1	OD continue normal operation. CANda shall quit generating key events and will stay on same screen till timeout and then jump to default screen.	Continue normal operation. Technician interface available	Display Assembly has a stuck key	Faulty Display Assembly
174	Suction Pressure Sensor Fault	SUCT P SENSE	0	Shutdown and enter a hard lockout. Compressor locked out until power cycle and requires service call.	Power cycle. After power cycle, the compressor shall resume normal operation.	Pressure transducer is missing, open, shorted or out of range.	Wiring or component failure. (System under vacuum or suction pressure over 500psig)
175	Limp Along Mode	LIMP MODE	0	High or Low superheat detected for at least 20 minutes. Limp Mode can also be triggered by Loss of Sensor reading. Look for Sensor Error. Limit Compressor Speed to a constant value.	Ramp up to demand speed (normal operation)	High or Low superheat detected for at least 20 minutes. Limp Mode can also be triggered by Loss of Sensor reading. Look for Sensor Error. Limit Compressor Speed to a constant value.	Problem with refrigerant pressure or flow (high or low superheat). Sensor Faulted (out of range). Dome temp, suction temp, ambient temp, indoor EEV temp sensor (EEV in safe mode).
		LIMP MOD LO	1*	Loss of Suction Pressure Transducer reading forces shut down and Hard Lock	Can be cleared only on power cycle. After power cycle, the compressor shall resume normal operation.	Shutdown. Can't start system without Service being called. Send error to thermostat and alert menu in CANda	Failed suction pressure transducer, or multiple simultaneous sensor failures. Evaluate sensor failure alerts for troubleshooting / resolution.
		MAX SH LIMP	2	Limp along leaky bucket full	Power Cycle	Limp along mode max time expired	Charge, Airflow, EEV not closing, 3rd part coil
		LOW SH LIMP	3	Low SH	When SH goes to acceptable valve	Low SH	Charge, Airflow, EEV not closing, 3rd part coil
175	Suction Pressure Range Cutout / Limp Mode	SUCT P HI	1*		With a call for cooling capacity, the blower will turn on for up to 10 minutes in an attempt to lower the suction pressure. If the suction pressure is still above 375 psig at the 10 minute mark, the compressor will be allowed to run for up to 90 seconds. If the suction transducer is still out of range, a fault will then trigger.	For Outdoor Software Version 3. X and higher: **Compressor temporarily disabled due to the suction pressure transducer being out of range on the high end (above approx. 375 psig). Compressor will not be allowed to operate until pressure drops below approx. 365 psig. For Outdoor Software Version 1.0 & 2.0: **Compressor runs fixed speed due to high or low superheat in heating mode for an extended time period	Refrigerant static pressure is >375 psig due to high temperatures or a malfunction of the transducer.



Variable Speed Alert Codes

Alert Code	Alert Group	Display Assembly Text	Sub-alarm	State action on occurrence	State action on clearance	Alert Description	Possible Cause
176	Modbus Communication Failure	DRV COMM LO	0	With communication error message, the drive must shut down.	Can be cleared only on power cycle. After power cycle, the compressor shall resume normal operation.	Loss of internal communication within the Drive.	Loss of internal communication within the Drive. On a persistent 176.00 error, the technician should cycle power to the ODU. If error 176.00 returns, replace the Drive. If replacement Drive has the same issue, investigate for EMI and source.
		DRV COMM CO	1	As soon as communication error message flags, call shut down operation and then call communication check-up operation. Retry 10 times and then lockout.	Resume normal operation	Loss of communications between AOC and MOC	Open or damaged circuit between AOC and MOC
		AOC COMM CO	2	As soon as communications error, AOC should internally retry to establish communication with Demand micro. If unable, a reset of the AOC should occur. After 10 times the system should hard lockout	Resume normal operation	Loss of communications between main AOC micro and demand micro	Internal error
177	Drive Current Failure	CUR DER	0	Compressor speed Derated.	Ramp up to demand speed (normal operation).	Internal Derate is active due to high Drive output current	High load conditions.
		CUR EX DER	1	Compressor speed Derated. This alert shall be an indication of an extended Derated performance.	Ramp up to demand speed (normal operation).	Drive current is above threshold and the system is being Derated for an extended period of time.	High load conditions.
		SW CUR CO	2	Emergency shutdown. Control will clear the fault and retry every 5 minutes.	Resume normal operation	Drive output current exceeds internal limit set for current sensor	High load condition. Overcharge, dirty coil (s), low airflow, recirculation, compressor failure, Drive hardware failure (Run Drive Diagnostics).
		HW CUR CO	3	Emergency shutdown. Control will clear the fault and retry every 5 minutes.	Resume normal operation	Drive output current exceeds internal limit set for current sensor	Compressor failure (locked rotor, shorted windings), Drive hardware failure (Run Drive Diagnostics)
		CURRENT LO	4	Emergency shutdown	Can be cleared only on power cycle. After power cycle, the compressor shall resume normal operation.	5 occurrences of HW CUR CO in 1 hour, or 15 occurrences of SW CUR CO in 1 hour. Each hour of runtime without a HW or SW cutout will reduce the total count by 1.	High load conditions for 5 consecutive over current cutout periods. Go to Drive Diagnostic Test in CANda. Also see Compressor Verification Flowchart. Choke possibly not plugged in.
		FAN CUR CO	5	Shutdown AOC send "MOC clear alarm" message every 5 min and retries demand. After 10 retries also set universal hard lockout alarm	Resume normal operation	OD Fan IPM Overcurrent or OD FAn Current Detection Loop Fault has occurred from MOC	MOC Fan Overcurrent

**Variable Speed Alert Codes**

Alert Code	Alert Group	Display Assembly Text	Sub-alarm	State action on occurrence	State action on clearance	Alert Description	Possible Cause
178	DC Voltage Failure	DC HI CO	0	Emergency shutdown. Control will clear the fault and retry every 5 minutes.	Resume normal operation	DC bus voltage is greater than 480VDC	PFC hardware failure. Run Drive Diagnostic Test to verify failure. Call for tech support, record failure mode for warranty claim before replacing Drive. This error can occur after a power disconnect.
		DC LOW CO	1	Emergency shutdown. Control will clear the fault and retry every 5 minutes.	Resume normal operation	DC bus voltage is less than 220VDC	Low line voltage. Verify supply voltage is between 187 VAC and 253VAC. This error can occur after a power disconnect.
		DC EXC HI LO	2	DC Voltage Hi Lockout has occurred 10 times consecutively. Control will clear the fault and retry every 5 minutes.	Control will clear fault when condition no longer exists (DC bus voltage is less than 480VDC).	DC Bus excessive over voltage after 10 consecutive 5 minute cutouts (178.00)	PFC hardware failure. Run Drive Diagnostic Test to verify failure. Call for tech support, record failure mode for warranty claim before replacing Drive. This error can occur after a power disconnect.
179	Power Module Temperature Failure	REC TEMP DER	0	Compressor speed Derated.	Ramp up to demand speed (normal operation).	Rectifier temperature greater than the Derate threshold	High Load condition, heat sink performance loss (check thermal grease, cold plate torque)
		RECT EX DER	1	Compressor speed Derated. This alert shall be an indication of an extended Derated performance.	Ramp up to demand speed (normal operation).	Rectifier temperature greater than the Derate threshold and the system is being Derated for an extended period of time	High Load condition, heat sink performance loss (check thermal grease, cold plate torque) possible Drive hardware failure (Run Drive diagnostics)
		REC TEMP LO	2	Emergency shutdown	Can be cleared only on power cycle. After power cycle, the compressor shall resume normal operation.	Rectifier temperature greater than the shutdown threshold	High Load condition, heat sink performance loss (check thermal grease, cold plate torque) possible Drive hardware failure (Run Drive diagnostics) Call for tech support, record failure mode for warranty claim before replacing Drive.
		INV TEMP DER	3	Compressor speed Derated.	Ramp up to demand speed (normal operation).	Inverter temperature greater than the Derate threshold	High Load condition, heat sink performance loss (check thermal grease, cold plate torque)
		INV T EX DER	4	Compressor speed Derated. This alert shall be an indication of an extended Derated performance.	Ramp up to demand speed (normal operation).	Inverter temperature greater than the Derate threshold and the system is being Derated for an extended period of time	High Load condition, heat sink performance loss (check thermal grease, cold plate torque) possible Drive hardware failure (Run Drive diagnostics)

## Variable Speed Alert Codes

Alert Code	Alert Group	Display Assembly Text	Sub-alarm	State action on occurrence	State action on clearance	Alert Description	Possible Cause
179	Power Module Temperature Failure	INV TEMP LO	5	Emergency shutdown	Can be cleared only on power cycle. After power cycle, the compressor shall resume normal operation.	Inverter temperature greater than the shutdown threshold	High Load condition, heat sink performance loss (check thermal grease, cold plate torque) possible Drive hardware failure (Run Drive diagnostics) Call for tech support, record failure mode for warranty claim before replacing Drive.
		FAN IPM TEMP	6		Resume normal operation	Fan module over temp	Clod Plate not attached, thermal grease Control box ventilation High OD conditions
180	Supply Voltage Failure	HI PWR DER	0	Compressor speed Derated.	Ramp up to demand speed (normal operation).	Low supply voltage and/or high power output from Drive -compressor running at a reduced RPM (Derate)	Maximum power is reduced with line voltage less than 200 VAC. High load conditions, recirculation, dirty coils, low airflow
		LOW VOLT CO	2	Emergency shutdown. Control will clear the fault and retry every 5 minutes.	Resume normal operation	Supply voltage is less than 175VAC	Supply voltage is less than 175 VAC
180	Supply Voltage Failure	HIGH PWR CO	3	Shutdown and retry after 5 minutes	Resume normal operation	Drive output current exceeds internal limit set for current sensor	High load condition. Overcharge, dirty coil (s), low airflow, recirculation, compressor failure, Drive hardware failure (Run Drive Diagnostics)

## Variable Speed Alert Codes

Alert Code	Alert Group	Display Assembly Text	Sub-alarm	State action on occurrence	State action on clearance	Alert Description	Possible Cause
181	Gate Drive Failure	GATE DRV CO	0	IGBT Failure. Gate driver fault is activated. Control will clear the fault and retry every 5 minutes.	Control will clear fault when condition no longer exists, 10 occurrences of gate drive failure cause the control to trip lock, which can only be cleared with a power cycle.	Drive hardware failure alert	Drive hardware failure. 10 consecutive occurrences will result in an Err 181.07
	Motor Phase Loss Detection	PHS LOSS CO	2	Emergency shutdown. Control will clear the fault and retry every 5 minutes.	Resume normal operation. Control will clear fault when condition no longer exists.	Compressor cable connection or motor winding problem. (Verify wiring and windings)	Compressor cable connection or motor winding problem. (Verify wiring and windings) Run Drive Diagnostics to confirm failure mode.
	Stall Detection	STALL DET CO	4	Emergency shutdown. Locked Rotor. Control will clear the fault and retry every 5 minutes.	Resume normal operation. Control will clear fault when condition no longer exists.	Locked Rotor Condition has been detected	Locked Rotor Condition has been detected. Run Drive Diagnostics to confirm failure mode. Verify system is not grossly overcharged and that service valves are open. Replace compressor.
	Gate Drive Failure Trip Lock	GATE DRV LO	7	10 consecutive occurrences of gate drive failure	Control needs to be power cycled.	10 consecutive occurrences of gate drive failure alert	Drive hardware failure. Run Drive Diagnostic Test to confirm failure mode. Call for tech support, record failure mode for warranty claim before replacing Drive.
	Illegal Configuration	CONFIG ERR	8	Trip lock upon occurrence	Can only be cleared with a Power Cycle	Improper parameters used in Personality Module	Data in PM is corrupt or wrong PM installed.
	No Motor	NO MOTOR	9	Shutdown. Send "clear alarm" message every 5 min and retry demand	Resume normal operation	The compressor motor is not detected (all three windings are not detected)	Compressor cable missing or not plugged in, all compressor windings shorted open.

Variable Speed Alert Codes

Alert Code	Alert Group	Display Assembly Text	Sub-alarm	State action on occurrence	State action on clearance	Alert Description	Possible Cause
181	Initializa-tion Error	INIT ERR	10	Emergency Shutdown. Control will clear the fault and retry every 5 minutes.	Resume normal operation. Control will clear fault when condition no longer exists.	Internal fault with micro and cannot initialize	Cycle power. If error continues call for tech support, record failure mode for warranty claim before replacing Drive.
	ADC Supply Range exceeded	ADC SUP EX	11	Emergency shutdown. Control will clear the fault and retry every 5 minutes.	Resume normal operation. Control will clear fault when condition no longer exists.	Internal communication fault	If error continues call for tech support, record failure mode for warranty claim before replacing Drive.
	ADC Inverter temperature range exceeded	ADC INV T EX	12	Emergency shutdown. Control will clear the fault and retry every 5 minutes.	Resume normal operation. Control will clear fault when condition no longer exists.	Internal fault with temperature sensor.	If error continues call for tech support, record failure mode for warranty claim before replacing Drive.
	ADC Rectifier temperature range exceeded	ADC RECT EX	13	Emergency shutdown. Control will clear the fault and retry every 5 minutes.	Resume normal operation. Control will clear fault when condition no longer exists.	Internal fault with temperature sensor.	If error continues call for tech support, record failure mode for warranty claim before replacing Drive.
	ADC reference range exceeded	ADC REF EX	14	Emergency shutdown. Control will clear the fault and retry every 5 minutes.	Resume normal operation. Control will clear fault when condition no longer exists.	Internal fault with micro	If error continues call for tech support, record failure mode for warranty claim before replacing Drive.
	ADC current range error	ADC CUR EX	15	Emergency shutdown. Control will clear the fault and retry every 5 minutes.	Resume normal operation. Control will clear fault when condition no longer exists.	Internal fault with current sensor	If error continues call for tech support, record failure mode for warranty claim before replacing Drive.
	ADC	MOC INT FLT	16	Shutdown	Resume normal operation when fault no longer exists	Drive internal protections fault	Improper drive configuration or drive grounding. Call for drive authorization if alert continues
	ADC	MOC SENS INT FLT	17	Shutdown	Resume normal operation when fault no longer exists	Heat Sink Temperature sensor fault	Improper drive configuration or drive grounding. Call for drive authorization if alert continues
182	Startup Algorithm Fault	STRT SOFT LO	0	Can't execute start-up algorithm Can't start system for at least 5 minutes. Proceed to Normal shutdown. Send "Wait" to thermostat, send Alert to CANda home screen menu and history	Resume normal operation	Compressor has a failed startup attempt.	Drive is limiting compressor speed due to Inverter high temperature or high current.
		STRT HARD LO	1	Shutdown. Can't start system without Service being called. Send error to thermostat and alert menu in CANda	Can be cleared only on power cycle. After power cycle, the compressor shall resume normal operation.	5 startup soft lockouts occurred without a successful start.	Drive is limiting compressor speed due to Inverter high temperature or high current.
		COMP STRT FLT	2	Shutdown soft lock 5 minutes	Resume normal operation when fault no longer exists or-proceed to Hard Lockout	Compressor failed to reach startup speed within 3 minutes	Other possible faults contributing Refrigerant overcharge Liquid in compressor- new startup. Allow Sump heat
183	Shutdown Algorithm Fault	SHTDWN CO	0	Control is reset internally. Retry after 5 minutes.	Resume normal operation after compressor comes to a halt.	Compressor does not come to a complete stop even after the defined time and continues to run even after control is released.	Loss of internal communication. If error continues after system resets, call for tech support.

**Variable Speed Alert Codes**

Alert Code	Alert Group	Display Assembly Text	Sub-alarm	State action on occurrence	State action on clearance	Alert Description	Possible Cause
184	Protection Algorithm Fault	IDCF CO	0	Shutdown. Soft lockout. Send "Wait" to thermostat, send Alert to CANda home screen menu and history	Resume normal operation after suction pressure is greater than 107psig (35°F saturated) and compressor cutout time has elapsed. Cut Out Time = 5 minutes	(In cooling mode) Indoor coil freeze protection is active. Suction pressure sensor is <78psig (20°F saturated) for 20 minutes.	Restricted airflow, low charge, low ambient operation, restriction in refrigerant system or metering device.
184	Protection Algorithm Fault	CDT HI SP CO	1	Shutdown. Soft lockout. Send "Wait" to thermostat, send Alert to CANda home screen menu and history	Resume normal operation after cutout time has elapsed. CO=15 minutes	Compressor High Temperature Protection at High Speed- Shutdown (Dome Temp Sensor).	High super heat at compressor - Low charge, restricted metering device, restricted condenser airflow in cooling mode, sensor accuracy, high indoor ambient in heat mode, (Indoor set point above 80°F) (Increase IDairflow)
		CDT LO SP CO	2	Shutdown. Soft lockout. Send "Wait" to thermostat, send Alert to CANda home screen menu and history	Resume normal operation after compressor cutout time has elapsed. CO=15 minutes	Compressor High Temperature Protection at Low Speed-Shutdown (Dome Temp Sensor).	High super heat at compressor - Low charge, restricted metering device, restricted condenser airflow in cooling mode, sensor accuracy, high indoor ambient in heat mode, (Indoor set point above 80°F) (Increase ID airflow)
		LSPP CLG CO	3	Shutdown. Soft lockout. Send "Wait" to thermostat, send Alert to CANda home screen menu and history	Resume normal operation after compressor cutout time has elapsed. CO=5 minutes	Low Suction Pressure Protection in Cooling Mode. Less than 50 PSIG	Low charge, EEV pump down, restriction. Pressure transducer calibration.
		LSPP HTG CO	4	Shutdown. Soft lockout. Send "Wait" to thermostat, send Alert to CANda home screen menu and history	Resume normal operation after compressor cutout time has elapsed. CO=5 minutes	Low Suction Pressure Protection in Heating Mode. Less than 25 PSIG	Low charge, EEV pump down, restriction. Pressure transducer calibration. Extremely low outdoor ambient (ODT less than minus 10°F)
		MCLP CO	5	Shutdown. Soft lockout. Send "Wait" to thermostat, send Alert to CANda home screen menu and history	Resume normal operation after compressor cutout time has elapsed. CO=5 minutes	Maximum Current Low Speed Protection. High compressor load during low speed operation.	System operating under temperature extremes. Possible Derate condition, high compression ratio, damaged compressor (bearings/scroll set galled). Check for high dome temperature alert in previous history.
		DIAGCUR CO	6	Shutdown. Soft lockout. Send "Wait" to thermostat, send Alert to CANda home screen menu and history	Resume normal operation after compressor cutout time has elapsed. CO=5 minutes	In the compressor heating mode, current has exceeded allowable limit at the operating conditions.	At high speed operation (3600 RPM and above) Drive output current limit has been exceeded. Check for low indoor airflow, high system charge.
		MAX NORM LO	7	Can't start system without Service being called. Send error to thermostat and alert menu in CANda	Can be cleared only on power cycle. After power cycle, the compressor shall resume normal operation.	Maximum number of protection shutdowns (Err 184.xx) have occurred.	Check previous history for 184.xx faults leading to lockout.
		HARD LOCKOUT	8	Can't start system without Service being called. Send error to thermostat and alert menu in CANda	Can be cleared only on power cycle. Resume normal operation.	Universal Hard Lockout. Outdoor EEV will drive open.	Occurs anytime the system enters the Hard Lockout State. Investigate Alerts leading to this condition.

## Variable Speed Alert Codes

Alert Code	Alert Group	Display Assembly Text	Sub-alarm	State action on occurrence	State action on clearance	Alert Description	Possible Cause
184	Protection Algorithm Fault	INT LUBE FLT	9	Send error to thermostat and alert menu in CANda history	5 Minute compressor soft lockout time has elapsed	Internal Lubrication Failure. For 60 minutes internal lube does not occur and compressor RPM is below the limitation for internal lube to be satisfied.	A Derate condition exists that does not allow internal lube speed to be achieved when needed. Check for cause of Derate.
		SOV MODE WRG	10	Unit running in opposite mode 5 minute soft lockout	Resume normal operation	LSOV is in heating mode when system is calling for cooling	Reprogram drive AOC software SOV disconnected or mounting. If alert continues, call for replacement authorization
185	Protection Derating Fault	CDTPHI HD	0	Dome temperature is high. Limit compressor speed to prevent higher load.		Compressor Dome Temperature Protection, Limit compressor speed.	Low outdoor ambient heating condition.
		CDTPHI DN	1	Dome temperature is high. Decrease compressor speed to reduce load.		Compressor Dome Temperature Protection, Derate compressor speed.	Low outdoor ambient heating condition.
		CDTPLO UP	2	Dome temperature is high. Increase compressor speed to improve compressor cooling.		Compressor Dome Temperature Protection, Increase compressor speed.	Low speed heating with high indoor ambient.
		CDTPLO HD	3	Dome temperature is high. Limit compressor speed to prevent higher load.		Compressor Dome Temperature Protection, Limit compressor speed.	Low speed heating with high indoor ambient.
		CMPR LUBE	5			Compressor Lubrication cycle.	Low speed operation requires periodic lubrication cycle.
		MCLP UP	6	Low compressor speed with high Drive output current. Increase speed.		Low compressor speed with high Drive output current, Increase compressor speed.	Low speed with high condenser load. (Indoor coil in heating mode/outdoor coil in cooling mode)
		MCLP HD	7	Low compressor speed with high Drive output current. Hold speed.		Low compressor speed with high Drive output current, Limit compressor speed.	Low speed with high condenser load. (Indoor coil in heating mode/outdoor coil in cooling mode)
		CLG DERATE	8	Suction saturation temperature is 28 degrees for less (92 PSIG) for at least 20 minutes.	Saturated suction temperature is 35 degrees For higher (107 PSIG)	Indoor coil freeze protection is active, Derate compressor speed.	In cooling mode: low indoor/outdoor ambient operation. Low airflow, low humidity, Low RH dehumidification target.
		SYS OR	9			System Oil Return function active to bring oil back to compressor.	Low Dome temperature with an ON cycle and/or multiple short cycles.
		LSPPCLG DN	10	Suction pressure is low		Low Suction Pressure Protection in cooling mode, Derate compressor speed.	In cooling mode: low indoor/outdoor ambient operation.

## Variable Speed Alert Codes

Alert Code	Alert Group	Display Assembly Text	Sub-alarm	State action on occurrence	State action on clearance	Alert Description	Possible Cause
185	Protection Derating Fault	LSPPCLG HD	11	Suction pressure is low		Low Suction Pressure Protection in cooling mode, Limit compressor speed.	In cooling mode: low indoor/outdoor ambient operation.
		LSPPHGT DN	12	Suction pressure is low		Low Suction Pressure Protection in heating mode, Derate compressor speed.	In heating mode: low outdoor ambient/indoor temperature operation.
		LSPPHGT HD	13	Suction pressure is low		Low Suction Pressure Protection in heating mode, Limit compressor speed.	In heating mode: low outdoor ambient/indoor temperature operation.
		DIAGCUR DN	14	Drive output current is high		High compressor speed with high Drive output current, Derate compressor speed.	In heating mode, high indoor coil load or high outdoor ambient.
		DIAGCUR HD	15	Drive output current is high		High compressor speed with high Drive output current, Limit compressor speed.	In heating mode, high indoor coil load or high outdoor ambient.
<b>* ALL 185 FAULTS DO NOT POPULATE IN THERMOSTAT FAULT HISTORY WITH VSPD 3.0 SOFTWARE. THESE ONLY POPULATE IN OUTDOOR CANda FAULT HISTORY. * THIS STARTS WITH 3.0 SOFTWARE.</b>							
186	MOC Protection Derating Fault	MCP HD	0	Drive output current is high		High Drive output current, Limit compressor speed.	High compressor load
		MCP DN	1	Drive output current is high		High Drive output current, Derate compressor speed.	High compressor load
		MTP HD	2	Drive Inverter temperature is high		High Inverter temperature, Limit compressor speed.	High compressor load
		MTP DN	3	Drive Inverter temperature is high		High Inverter temperature, Derate compressor speed.	High compressor load
		RTP HD	4	Drive Rectifier temperature is high		High Rectifier temperature, Limit compressor speed.	High compressor load
		RTP DN	5	Drive Rectifier temperature is high		High Rectifier temperature, Derate compressor speed.	High compressor load
		INPUT CUR HD	6	High Drive input current		High Drive input current, limit speed	High compressor load
		INPUT CUR DN	7	High Drive input current		High Drive input current, reduce speed	High compressor load



Variable Speed Alert Codes

Alert Code	Alert Group	Display Assembly Text	Sub-alarm	State action on occurrence	State action on clearance	Alert Description	Possible Cause
186	MOC Protection Derating Fault	FAN CUR HD	8	High OD fan current		High OD fan current, limit speed	Low ambient heating, heavy rains, ice bridging, fan obstruction
		FAN CUR DN	9	High OD fan current		High OD fan current, reduce speed	Low ambient heating, heavy rains, ice bridging, fan obstruction
		CLD PLT HD	10	Cold plate temperature requires a hold condition	Resume normal operation	Excessive Drive temperature at liquid line cold plate	Loss of charge, loose cold plate, missing thermal paste, condenser fan failure, dirty condenser coil.
	Protection Derate Fault	CLD PLT DN	11	OD Unit Operation Limit Speed	Resume normal operation following 15 min soft lock. Drive must be below 165°F	High Drive Chassis Temp	Loss of charge, loose cold plate, missing thermal paste, condenser fan failure, dirty condenser coil
		FAN TEMP HD	12	Fan speed limited	Resume normal operation when fault no longer exists	OD Fan power module temperature high	High Load Heat sink performance loss
		FAN TEMP DN	13	Fan speed limited	Resume normal operation when fault no longer exists	OD Fan power module temperature high	High Load Heat sink performance loss
187	Evacuation Mode	EVACUATION	0	Outdoor unit operation shall not be allowed. EEV drives to full open.	Resume normal operation after Power Cycle	Evacuation mode has been executed from the CANda. ODU operation is locked out and EEV drives to full open.	Evacuation mode has been executed from the CANda.
187	Drive Diagnostics Mode	DRV TEST	1	Drive diagnostic test has been executed - send alert message to thermostat and CANda.	Exit the drive test at the CANda, after 120 minute time out or by power cycling the unit.	Drive Diagnostics Test is in progress	Technician to determine after running the diagnostic test. See CANda Technicians Control menu. This information will be required for warranty replacement part credit.
188	Storage Load Failure	STR LOAD F	0	Shutdown	Cycle Power to clear hard lockout condition	Internal Error	Cycle Power. If error does not clear, call for tech support, record failure mode for warranty claim before replacing Drive.
	Storage Update Failure	STR UPD F	1	Shutdown	Cycle Power to clear hard lockout condition	Internal Error	Cycle Power. If error does not clear, call for tech support, record failure mode for warranty claim before replacing Drive.
	State Failure	STATE ERR	2	Shutdown	Cycle Power to clear hard lockout condition	Internal Error	Cycle Power. If error does not clear, call for tech support, record failure mode for warranty claim before replacing Drive.
	Hardware Variant Read Failure	HW VAR RD F	3	Shutdown	Cycle Power to clear hard lockout condition	Internal Error	Cycle Power. If error does not clear, call for tech support, record failure mode for warranty claim before replacing Drive.
	Application Exception	APP EXCP	4	Shutdown	Cycle Power to clear hard lockout condition	Internal Error	Cycle Power. If error does not clear, call for tech support, record failure mode for warranty claim before replacing Drive.

## Variable Speed Alert Codes

Alert Code	Alert Group	Display Assembly Text	Sub-alarm	State action on occurrence	State action on clearance	Alert Description	Possible Cause
188	No Configuration	NO CONFIG	5	Shutdown	Cycle Power to clear hard lockout condition	Internal Error	Verify that PM is installed and matches the model number and serial number of unit. Cycle Power. If error does not clear, call for tech support, record failure mode for warranty claim before replacing Drive.
	Bad Configuration	BAD CONFIG	6	Shutdown	Cycle Power to clear hard lockout condition	Internal Error	Verify that PM is installed and matches the model number and serial number of unit. Cycle Power. If error does not clear, call for tech support, record failure mode for warranty claim before replacing Drive.
	Voltage VPOS Low	VPOS LOW	7	Shutdown	Cycle Power to clear hard lockout condition	Internal Error	Cycle Power. If error does not clear, call for tech support, record failure mode for warranty claim before replacing Drive.
188	Voltage VPOS High	VPOS HIGH	8	Shutdown	Cycle Power to clear hard lockout condition	Internal Error	Cycle Power. If error does not clear, call for tech support, record failure mode for warranty claim before replacing Drive.
	Voltage VCC Low	VCC LOW	9	Shutdown	Cycle Power to clear hard lockout condition	Internal Error	Cycle Power. If error does not clear, call for tech support, record failure mode for warranty claim before replacing Drive.
	Voltage VCC High	VCC HIGH	10	Shutdown	Cycle Power to clear hard lockout condition	Internal Error	Cycle Power. If error does not clear, call for tech support, record failure mode for warranty claim before replacing Drive.
	MOC Internal Err	OD FAN COMM CO	11	OD unit operation not allowed	Resume normal operation	MOC OD fan Comm Fault	Open Fan Circuit, Winding or wiring
189	Control Board Temperature High	BRD TEMP DER	0	Compressor speed Derated	Control must clear the flag when this condition no longer exists.	Compressor Actual speed not equal to compressor requested speed Limit compressor RPM.	High ambient conditions, recirculation discharge air, blocked coil, sensor calibration.
		BRD TEMP CO	1	Shutdown and retry after 5 minutes	Resume normal operation	Control board temperature is high. Shutdown and retry after 5 minutes.	High ambient conditions, recirculation discharge air, blocked coil, sensor calibration.

## Variable Speed Alert Codes

Alert Code	Alert Group	Display Assembly Text	Sub-alarm	State action on occurrence	State action on clearance	Alert Description	Possible Cause
191	OD Fan Fault	FAN PHS LOSS	0	Shutdown AOC send "MOC clear alarm" message every 5 min and retries demand. After 10 retries also set universal hard lockout alarm	Resume normal operation	Outdoor fan motor lost phase	Fan motor cable missing or not plugged in. Open winding in fan motor or harness. Loose wire connection in OD fan molex plus
		FAN ROTATE FLT	1	Shutdown AOC send "MOC clear alarm" message every 5 min and retries demand. After 10 retries also set universal hard lockout alarm	Resume normal operation	Outdoor fan is unable to reach target speed	Look for fan obstructions (possible ice bridging) or strong winds. Run drive diagnostics. Install a wind baffle kit if drive diagnostics passes and reverse rotation alarm returns.
Local	Unit Bus Fault1	UNIT BUS FLT 1 CANda COM ERR	0	IPC3 communication link is not active or the Node ID is not configured No bus manager or IPC3 bus time out	CANda is configured OR OD starts communicating on IPC3	No information to or from technician interface. Test modes, monitor, alerts and config menus lost.	Loss of communication between IVSC and CANda. Check wire harness and connections between IVSC plug J2 and CANda.
Local	Unit Bus Fault2	UNIT BUS FLT 2 CANda COM BUSY	1	The content provider is not responding, i.e. no acknowledgement message from content provider even after retries	CANda starts responding.	No information to or from technician interface. Test modes, monitor, alerts and config menus lost.	IVSC or CANda could be at fault. When system operates as expected, the CANda has most likely failed.
Local	Keypad Error	CANda will stay on same screen till timeout and then jump to default screen	2	A key/keys are continuously pressed for more than one minute	Key/keys are released	A key/keys are continuously pressed for more than one minute.	Key(s) were held down for too long or there is a stuck key.
ERR. 67.02	Normal	LIQ T Sense			Liquid Temp Sensor Fault	Liquid temperature sensor fault	Liquid temp sensor open or shorted **Zero or infinite resistance  Liquid temp sensor out of range **Compare resistance value of sensor to chart in literature  No output voltage from control board to sensor **A reading between 3vDC and 5vDC with the sensor removed confirms a good source voltage
ERR. 113.00	Normal	LIQ P Sense			Liquid Pressure Sensor Fault	Liquid pressure sensor fault	Liquid Pressure Sensor shorted or open **0vDC = Shorted **4.99vDC = Open  Liquid Pressure Sensor out of range **Compare DC volt value of sensor to chart in literature  No output voltage from control board **With sensor disconnected, 5vDC should be measured on control board

# Refrigeration Circuits for Heating and Cooling

## Heating Models

Figure 5. 2 Ton HP (X24 Models)

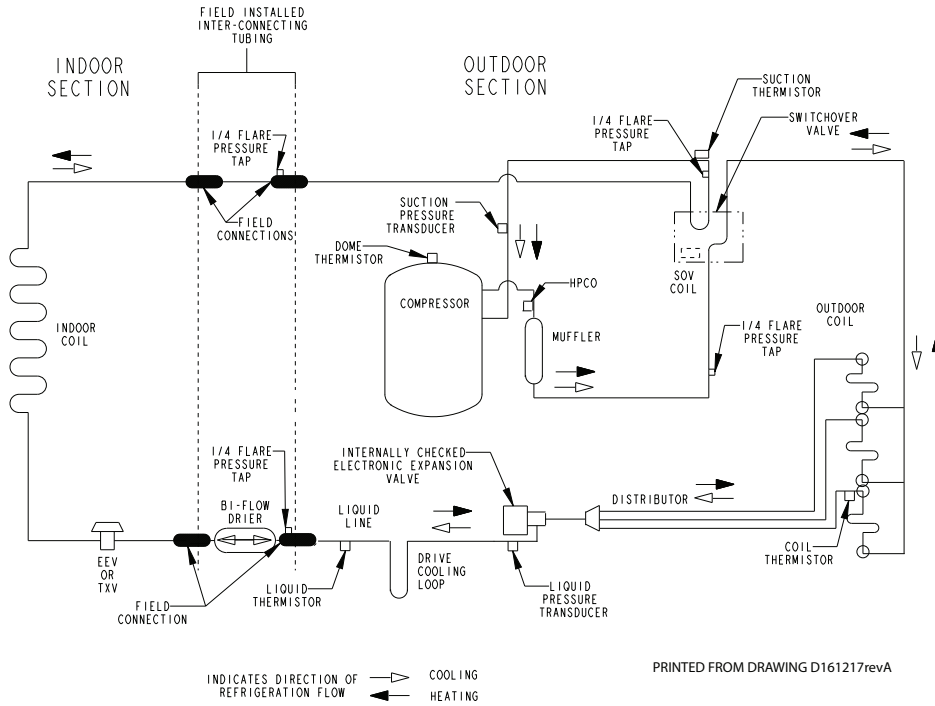
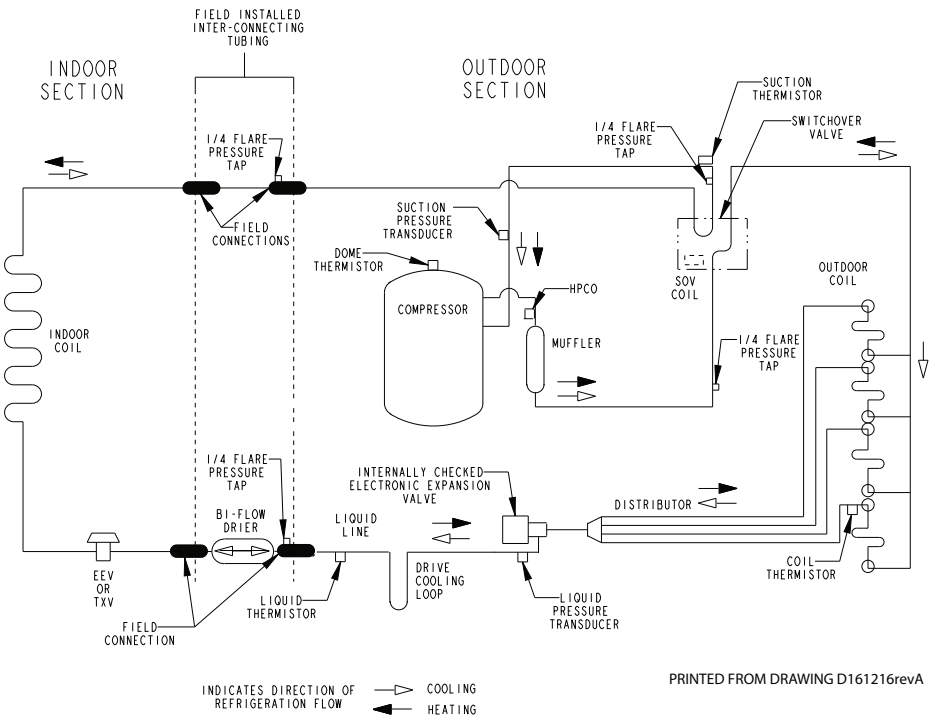

Figure 6. 3 Ton HP (X36 Models)



Refrigeration Circuits for Heating and Cooling

Figure 7. 4 Ton HP (X48 Models)

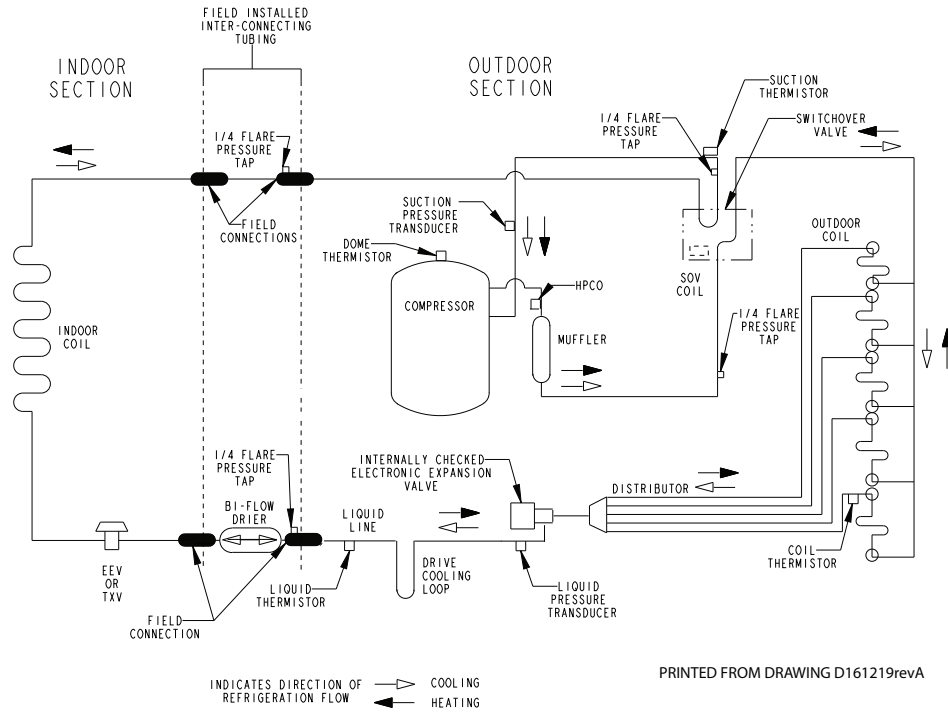
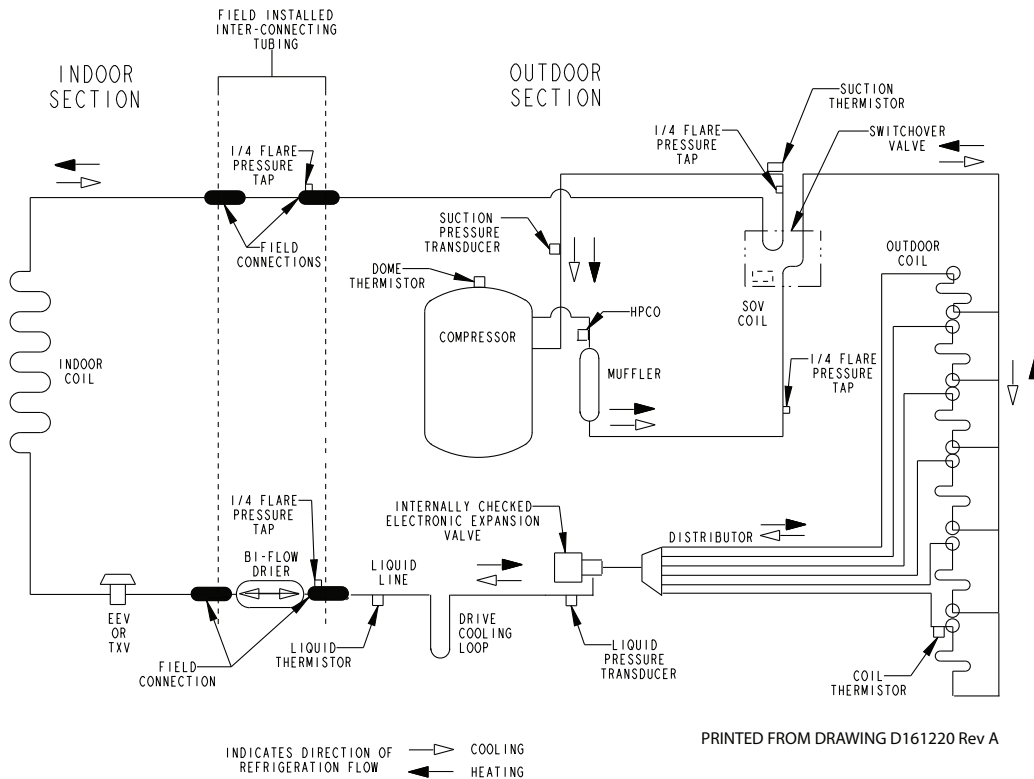

Figure 8. 5 Ton HP (X60 Models)



## Refrigeration Circuits for Heating and Cooling

### Cooling Models

**Figure 9. 2 Ton A/C (X24 Models)**

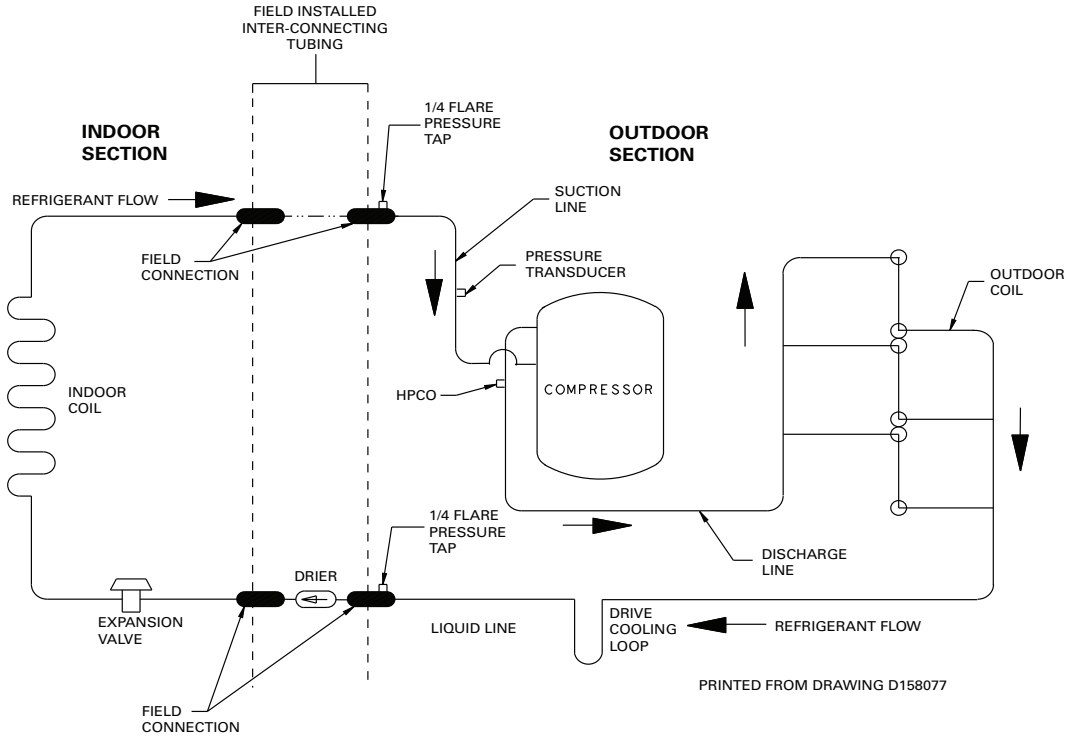

**Figure 10. 3 Ton A/C (X36 Model)**

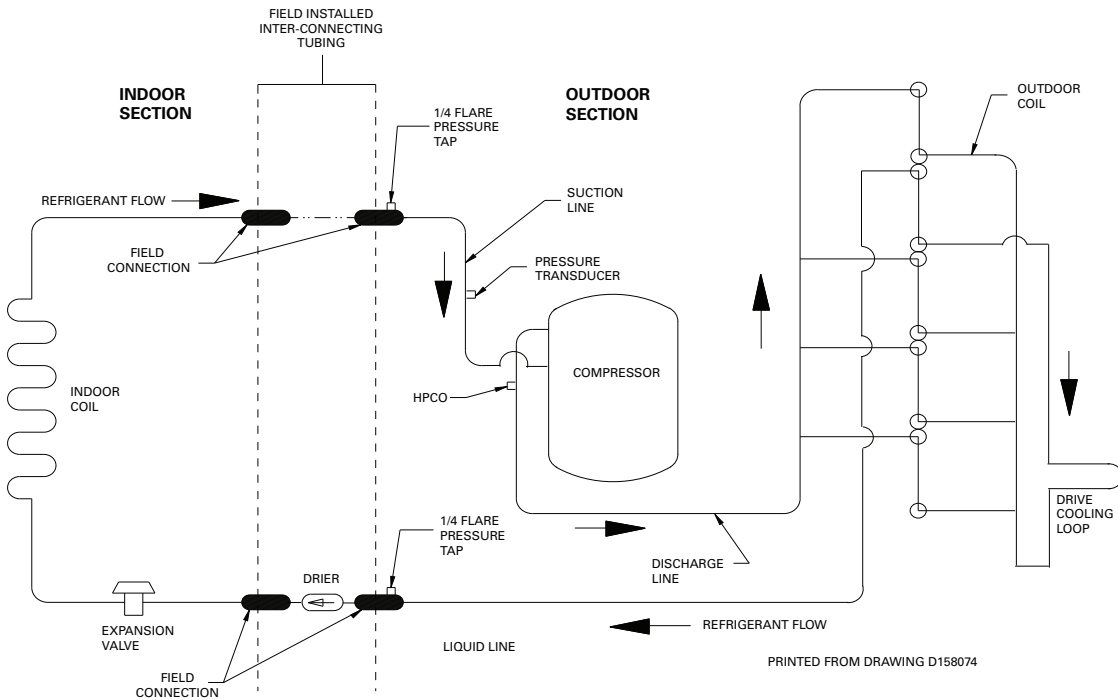

## Refrigeration Circuits for Heating and Cooling

Figure 11. 4 Ton A/C (X48 Models)

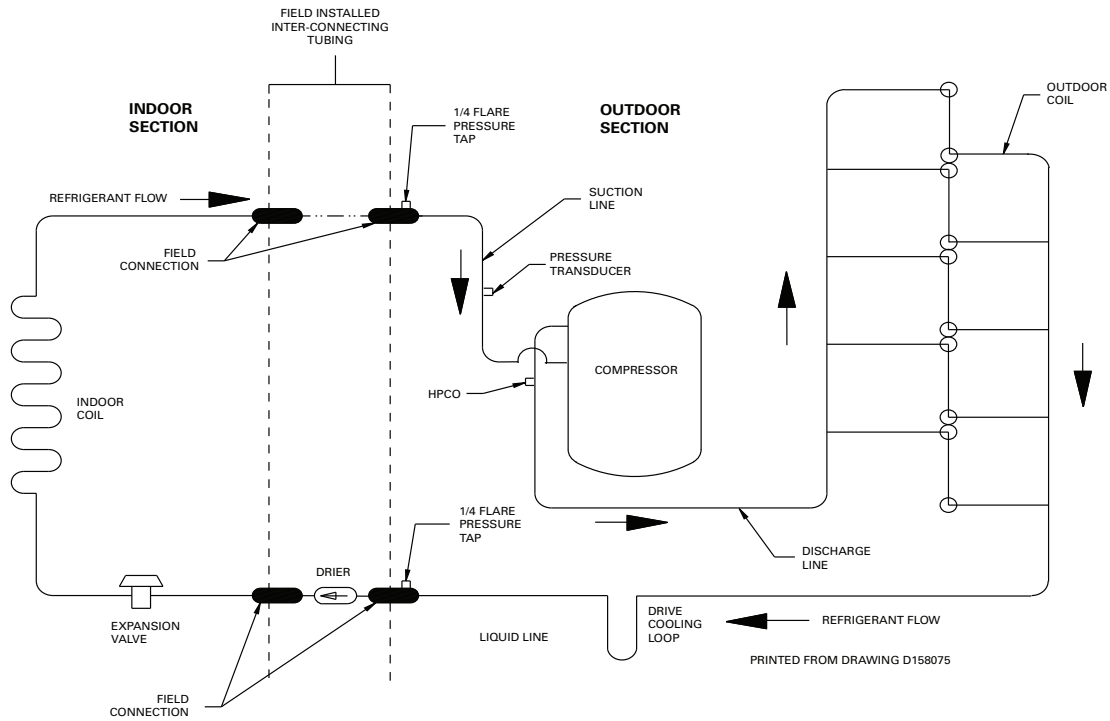
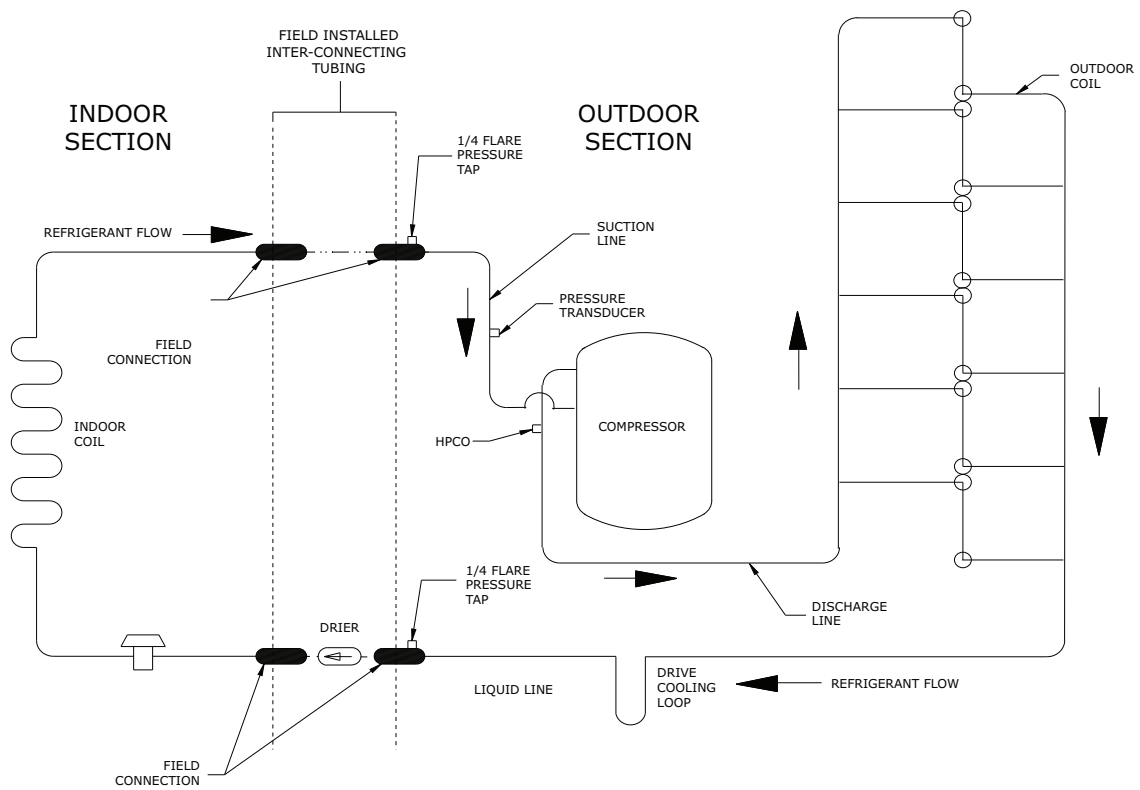

Figure 12. 5 Ton A/C (X60 Models)



## Load Shedding

### External Shutdown

External Shutdown is used for Load Shedding and applies to both heating and cooling modes of operation.

When applied, External Shutdown will allow for an operation to be interrupted when triggered by an external control device. Typical examples of external control devices are smart-home, home automation services, utility load shed/grid management, event/time of day pricing entities. While communicating devices and methodology of application are the responsibility of the provider, connection points with explanations of internal logic and trigger requirements are provided in this Technical Manual.

1. Configuring External Shutdown is accomplished at the UX360 or the Diagnostics Mobile App configuration menu. Field supplied wiring and ¼" stake-on hardware connections will be made at the

J2 and J3 Load Shed terminals on the AOC. All External Switch configurations are defaulted INACTIVE from the factory. External Switch inputs are ACTIVE-SENSED meaning that when the control senses a open circuit through an external control relay, the control will react to what has been configured.

2. The system will react to what was configured until the External Switch contacts close and 24 vac is again sensed at the ODU Load Shed contact J3. If the ODU is running and is configured to be disabled during Load Shed and the external contacts open, the ODU will start a shutdown routine and operations will be interrupted for as long as the contacts remain open. When the External Switch contacts are open, the UX360 will display "Load Shed Active".

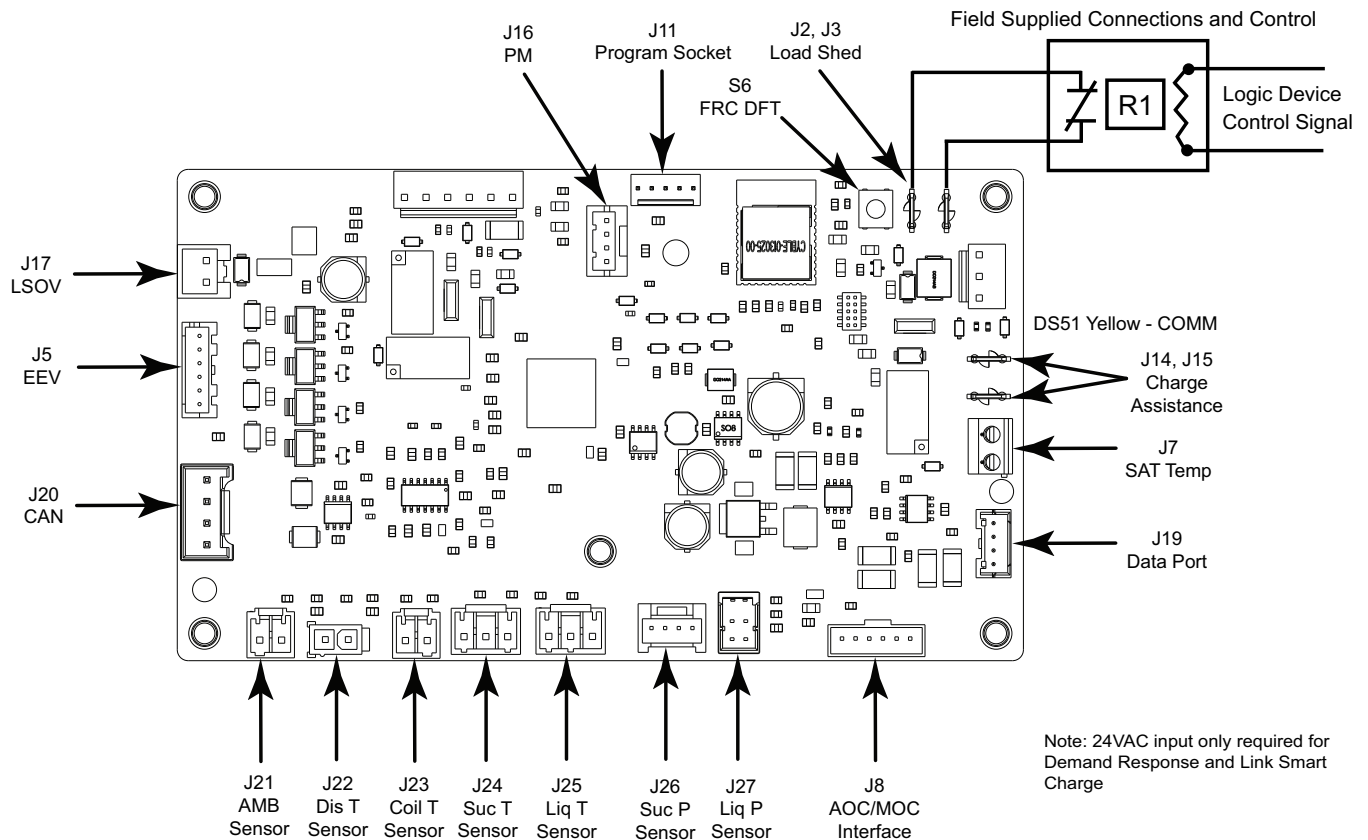

**Note:** External Switch configurations are found in the UX360 or Diagnostics Mobile App configuration menu.



# Communication Loss

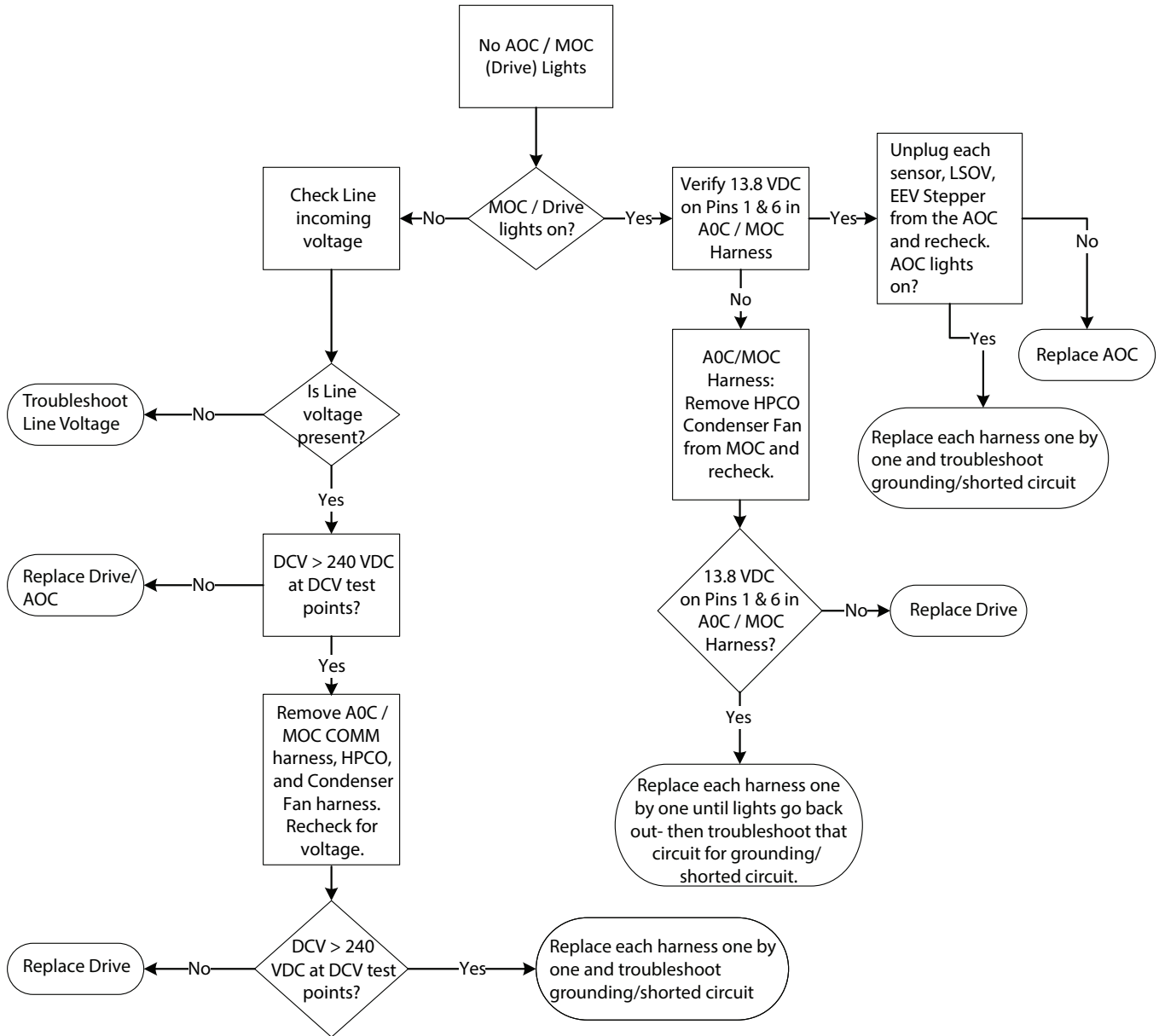

# Breaker Trip Procedure

**! WARNING**



**400 VOLTS  
ELECTRICAL HAZARD**

Failure to follow this warning could result in personal injury or death.

WAIT TWO (2) MINUTES after disconnecting power prior to touching electrical components as they may hold a dangerous charge of 400VDC, then verify DC Voltage is less than 42 VDC at inverter test points labeled +DC and -DC before servicing board.



## Breaker Trip Procedure

- Verify wiring
- Verify sensor readings
- Check breaker
- Check breaker size
- Check for GFCI on circuit
- Replace breaker if necessary

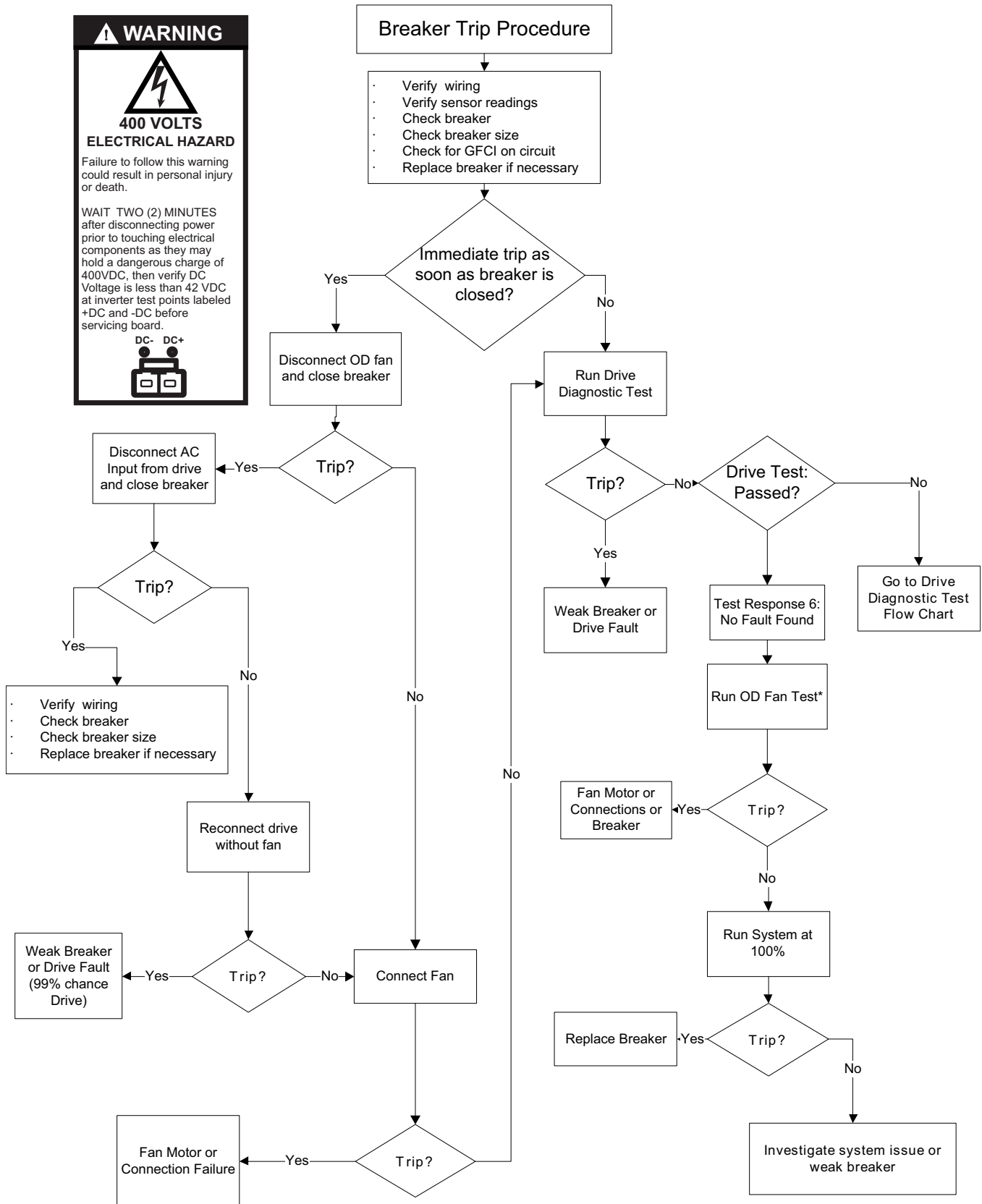

# Start Compressor

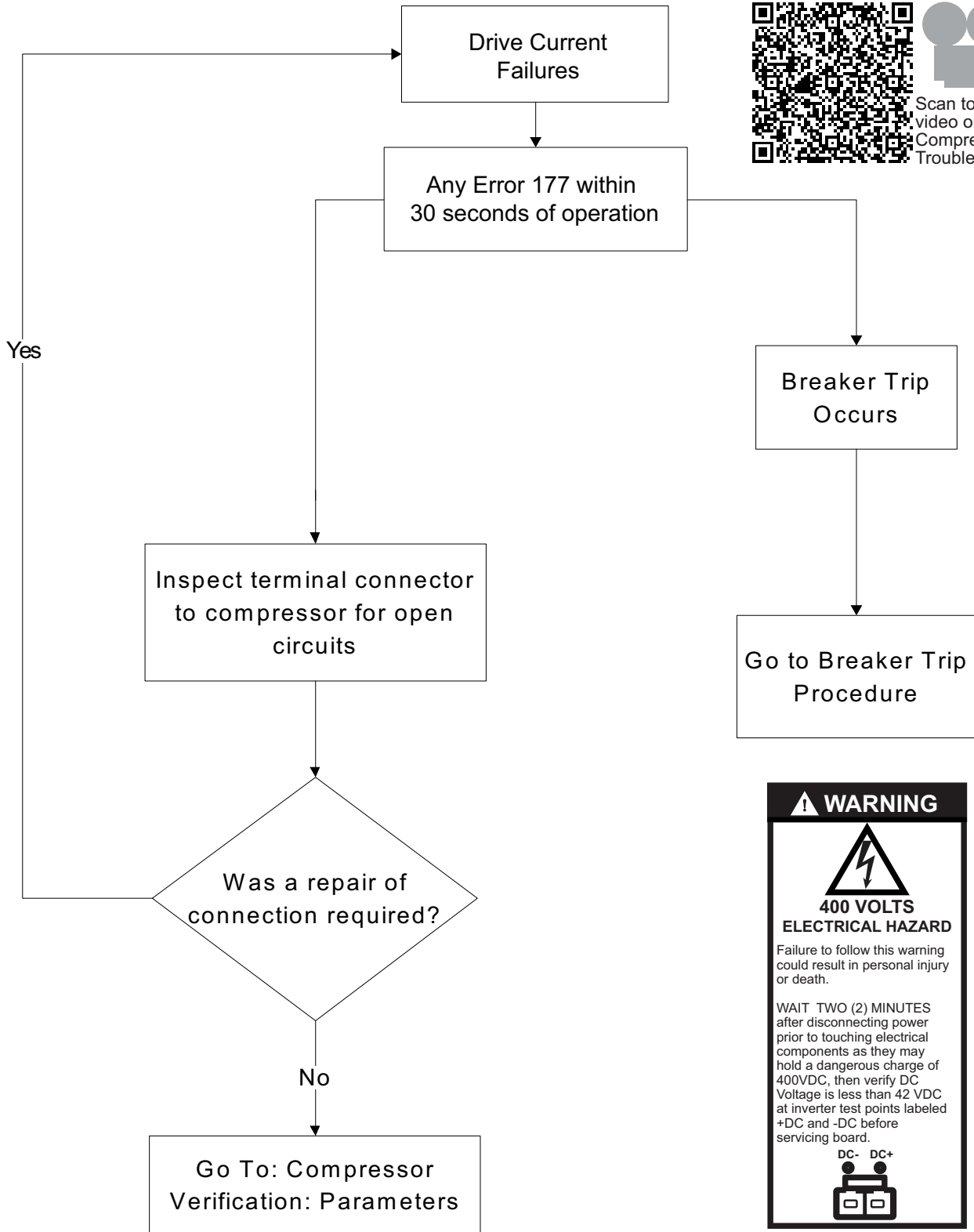

**⚠ WARNING**

**⚡**

**400 VOLTS  
ELECTRICAL HAZARD**

Failure to follow this warning could result in personal injury or death.

WAIT TWO (2) MINUTES after disconnecting power prior to touching electrical components as they may hold a dangerous charge of 400VDC, then verify DC Voltage is less than 42 VDC at inverter test points labeled +DC and -DC before servicing board.

DC- DC+

# Compressor Verification: Parameters

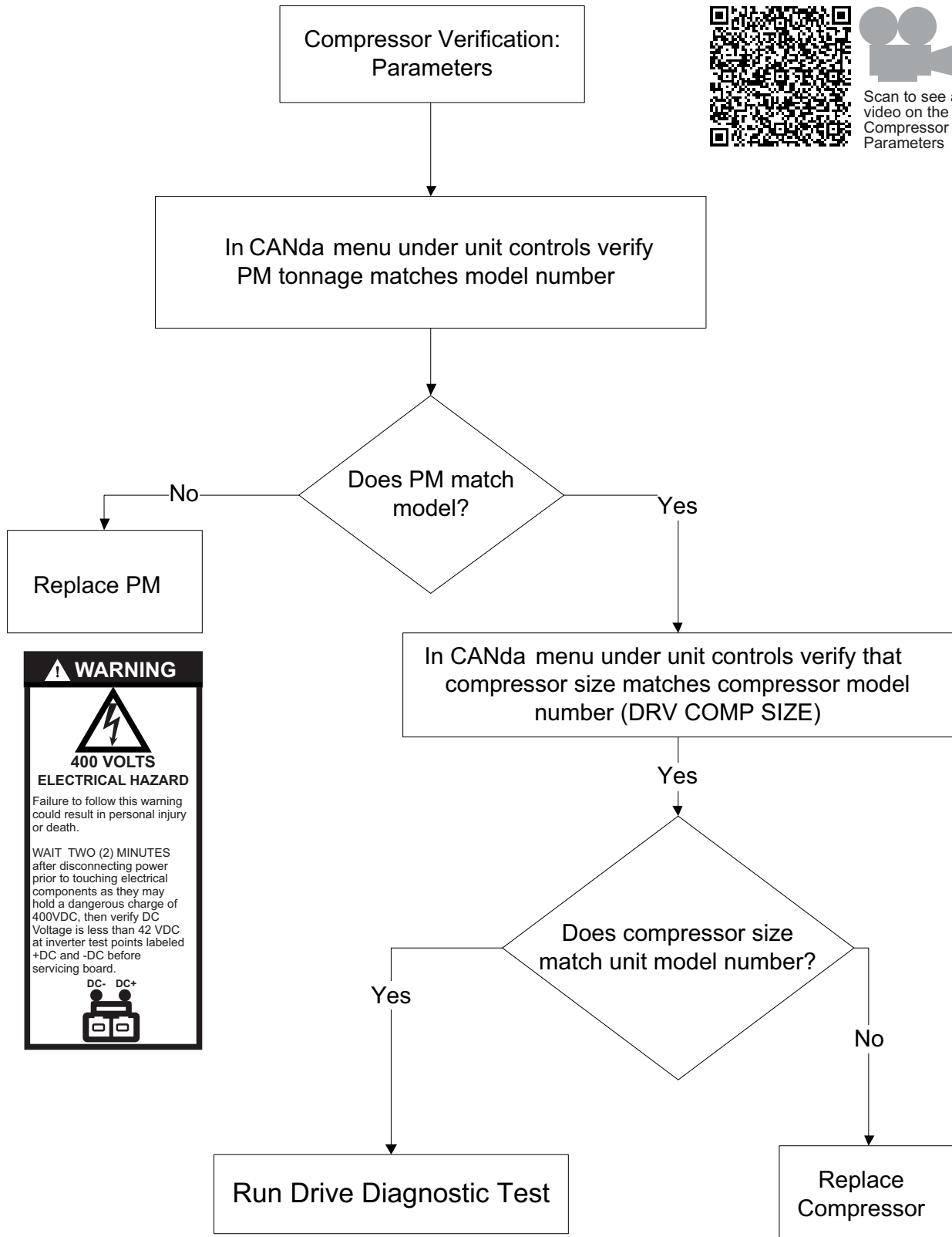

# Run Drive Diagnostic Test

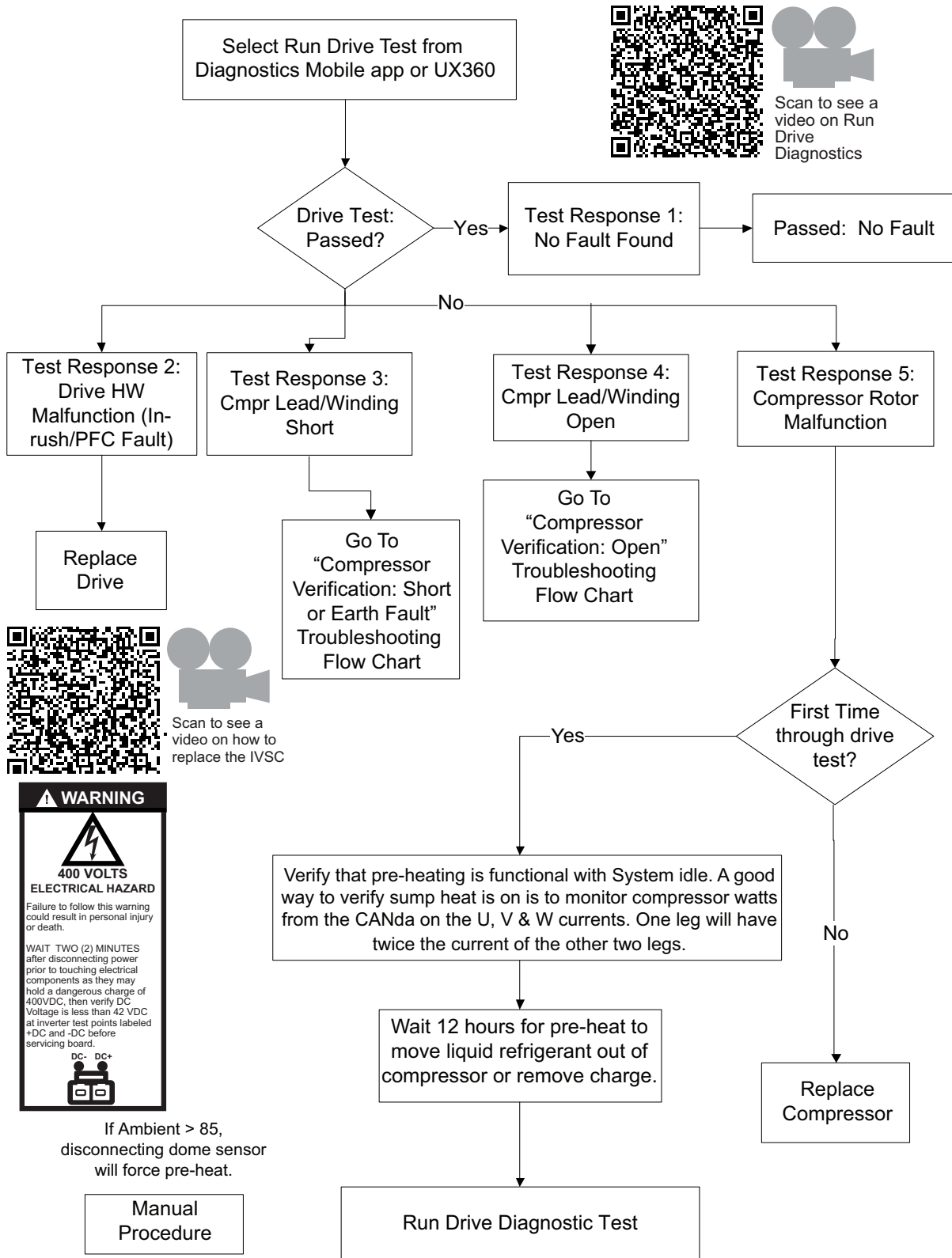

# Compressor Verification: Short

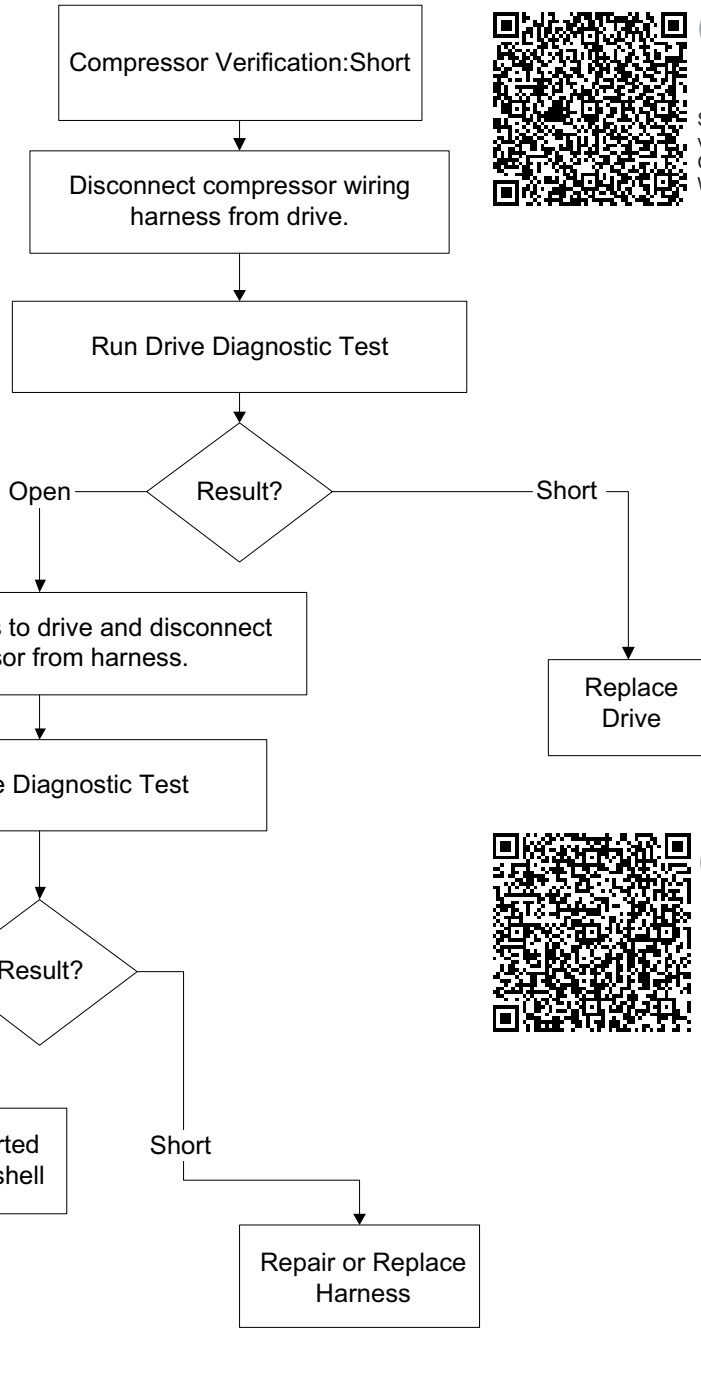
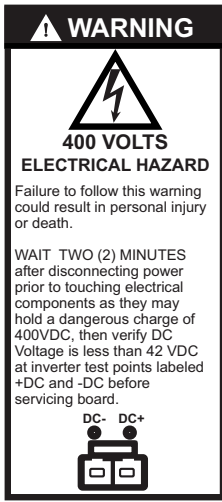

# Compressor Verification: Open

**⚠ WARNING**



**400 VOLTS  
ELECTRICAL HAZARD**

Failure to follow this warning could result in personal injury or death.

WAIT TWO (2) MINUTES after disconnecting power prior to touching electrical components as they may hold a dangerous charge of 400VDC, then verify DC Voltage is less than 42 VDC at inverter test points labeled +DC and -DC before servicing board.





Scan to see a video on Open Compressor Windings

Compressor Verification:  
Open

Disconnect compressor wire harness from drive and manually check resistance leg-to-leg

For reference: resistance should be 0.4-0.5 Ohms

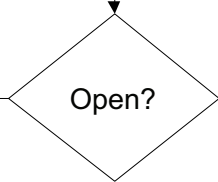

No

Yes

Visually Inspect Connection Points:  
Drive Side

Isolate harness. Check for continuity of harness leads

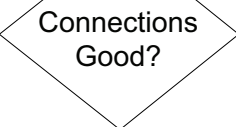

Yes

No

Replace Drive

Repair or Replace Harness

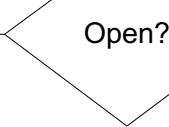

No

Yes

Verify Compressor Windings Open

Repair or Replace Harness

Replace Compressor



Scan to see a video on how to replace the IVSC

# Inverter Temperature

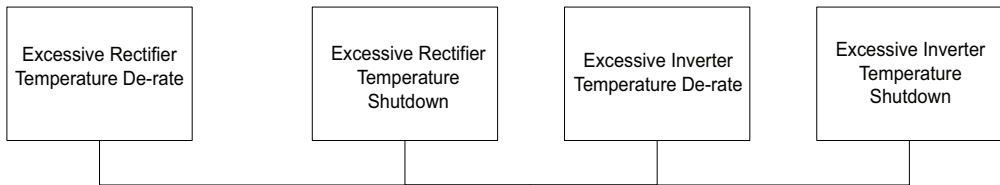

Scan to see a video on Inverter Temperature Troubleshooting

Check system condition: outdoor temp sensor, suction temp, suction pressure inverter temp, rectifier temp, dome temp and drive current for each leg, supply voltage

Is System in normal operating state?  
Verify operating range is within limits. See product specifications for more information.

Check for System Issue

Lack of Heat Dissipation  
Due to:  
OD fan failure in cooling  
ID fan failure in heating  
Ref. blockage  
Charge  
Non-Condensables

Visual/Mechanical Inspection of Heat Sink OK?  
Are all fasteners present  
Alignment of bracket  
Cracks in bracket  
Corrosion/pitting

Verify Module Temperature Sensors:  
1) Shutdown unit and wait at least 30 minutes  
2) Inverter and rectifier temperature sensors should both be close to the ambient temperature. Use CANda Monitor Menu.

Do Inverter/Rectifier temps look in range?

Disassemble Tube from cold plate  
Check Torque of screws (40-50 in. lbs.). Tighten mounting screws and/or re-do thermal paste

Cooling Issue: Drive Failure or still ambient condition issue

Sensor Fault  
Drive Failure

Proceed to Startup and check inverter and rectifier temperatures (normal range is less than 200F)

**⚠ WARNING**

**400 VOLTS  
ELECTRICAL HAZARD**

Failure to follow this warning could result in personal injury or death.

WAIT TWO (2) MINUTES after disconnecting power prior to touching electrical components as they may hold a dangerous charge of 400VDC, then verify DC Voltage is less than 42 VDC at inverter test points labeled +DC and -DC before servicing board.

DC- DC+



# Electronic Expansion Valve (EEV) Troubleshooting Flowchart

The Electronic Expansion Valve (EEV) installed in this heat pump is designed to control superheat entering the compressor when the system is running in mechanical heating mode. During cooling mode, refrigerant flow is controlled by the expansion device in the indoor unit. Therefore, any operational problems observed in cooling mode are not caused by the outdoor EEV.

The following flow chart was designed to assist in troubleshooting the EEV.

**Note:** The EEV closes with every OFF cycle in the heating mode of operation. During Defrost and in the Cooling mode of operation, the EEV will drive to full open.

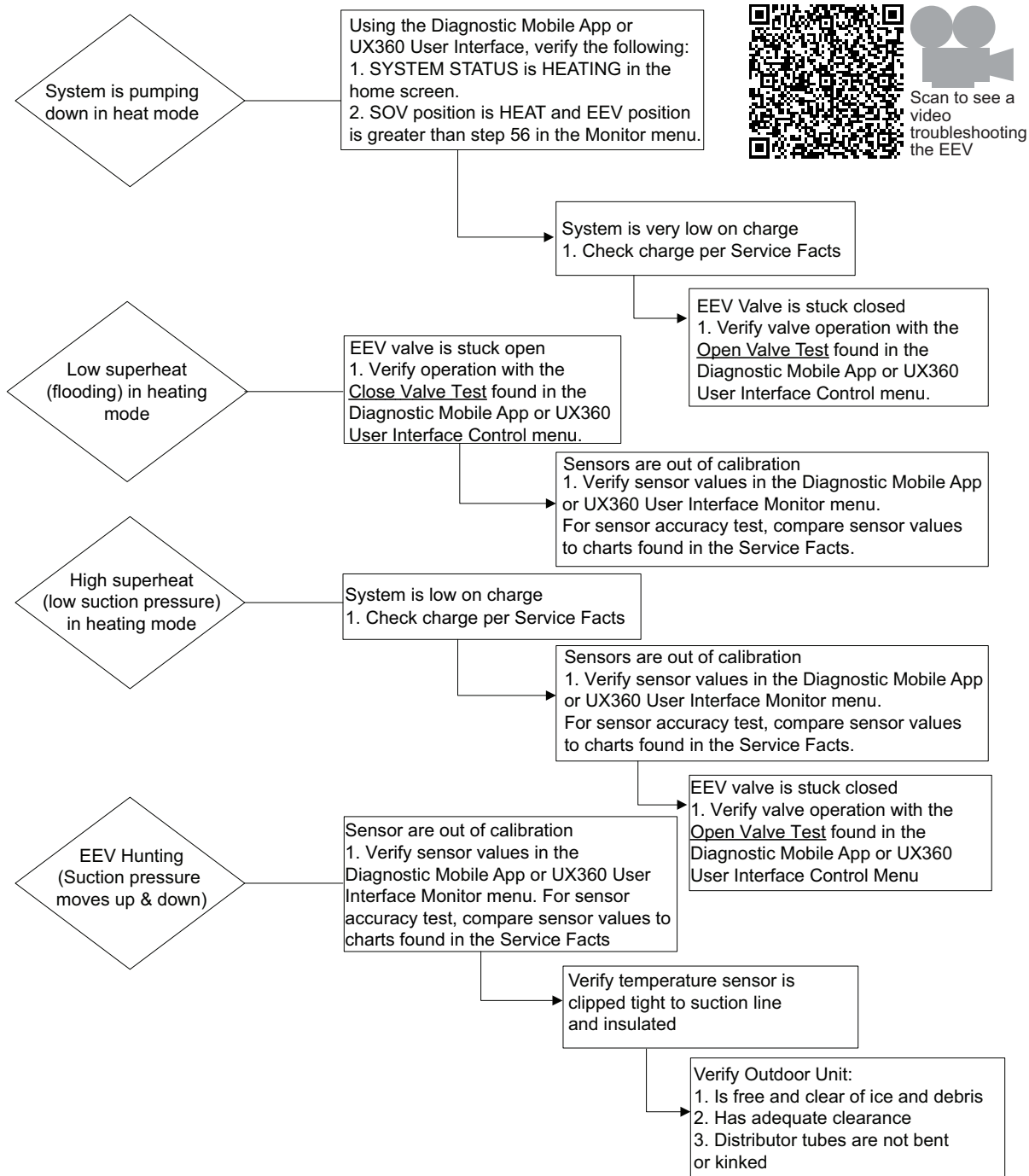

## Get the App

**Table 7. Get the APP:**

The Diagnostics Mobile App can be found in your device App Store when searching for Trane Diagnostics or American Standard Diagnostics. A QR code can be scanned which sends you directly to the location:

The Diagnostics Mobile App allows full system interaction and includes Configuration and Monitor menus. There are no onboard methods to configure outdoor unit parameters. These configurations need completed in the Diagnostics Mobile App or from the UX360 thermostat. Comfortsite or AsDealernet technician credentials are required to log in.

**Wait!**  
**Are you connected?**

Use the American Standard<sup>®</sup> or Trane<sup>®</sup> Diagnostics app to get connected to this equipment.

- Realtime alerts
- System verification
- System configuration
- Sensor monitoring

0346651P01

TRANE  
American Standard

## Sound Data

Model	Mode	Speed	A-Weighted Sound Power Level [dB(A)]	Full Octave Sound Power [dB]							
				63 Hz	125 Hz	250 Hz	500 Hz	1000 Hz	2000 Hz	4000 Hz	8000 Hz
4A6V7X24A	Cool	Min	55	70.9	50.3	51.8	52.3	50.4	42.0	37.7	39.9
	Cool	Max	66	76.3	65.2	62.7	64.1	60.5	55.7	49.5	45.0
	Heat	Min	61	69.8	52.9	52.8	57.5	55.2	51.9	47.4	46.5
	Heat	Max	70	75.9	66.0	64.7	67.3	65.6	57.0	52.2	47.7
4A6V7X36A	Cool	Min	56	71.5	51.5	54.7	54.4	52.2	43.1	36.8	38.5
	Cool	Max	71	74.1	69.4	65.9	70.5	65.1	59.4	54.2	49.5
	Heat	Min	61	68.3	52.1	53.9	57.6	55.1	52.9	45.1	47.8
	Heat	Max	75	78.7	70.3	76.3	73.0	68.7	61.1	57.3	53.6
4A6V7X48A	Cool	Min	62	70.6	55.0	55.9	55.8	59.0	49.9	41.1	42.9
	Cool	Max	74	75.7	71.9	73.0	74.2	68.5	63.4	59.1	54.3
	Heat	Min	63	72.1	59.3	58.7	60.3	58.6	51.3	46.0	45.2
	Heat	Max	76	77.9	74.5	77.0	75.4	69.5	64.4	60.8	56.2
4A6V7X60A	Cool	Min	58	69.7	59.5	57.6	55.1	52.0	45.0	41.6	42.3
	Cool	Max	73	83.9	73.7	73.1	71.2	67.9	64.4	58.9	51.8
	Heat	Min	61	71.9	61.3	59.0	61.3	56.2	48.7	45.1	45.5
	Heat	Max	74	85.8	75.7	74.4	73.2	68.5	63.6	59.6	55.9

NOTE: Rated in accordance with AHRI Standard 270

Model	Mode	Speed	A-Weighted Sound Power Level [dB(A)]	Full Octave Sound Power [dB]							
				63 Hz	125 Hz	250 Hz	500 Hz	1000 Hz	2000 Hz	4000 Hz	8000 Hz
4A7V7X24A	Cool	Min	57	71.2	49.8	51.4	58.3	51.6	44.2	37.4	41.2
	Cool	Max	66	74.8	64.1	61.3	66.2	61.2	56.3	49.4	46.5
4A7V7X36A	Cool	Min	56	71.0	53.4	51.2	53.5	51.5	44.6	40.3	41.0
	Cool	Max	71	73.1	70.5	65.8	67.3	66.0	60.9	54.1	50.0
4A7V7X48A	Cool	Min	62	70.7	52.5	51.7	55.3	53.4	43.6	35.1	41.6
	Cool	Max	74	75.5	73.6	72.0	72.8	68.7	63.9	58.3	52.1
4A7V7X60A	Cool	Min	62	71.7	55.8	56.8	56.7	60.1	44.7	42.3	41.0
	Cool	Max	75	87.8	77.6	75.2	72.2	70.2	64.7	59.0	51.1

NOTE: Rated in accordance with AHRI Standard 270

# Pressure Curves

Figure 13. 2 Ton HP(X24 Models)

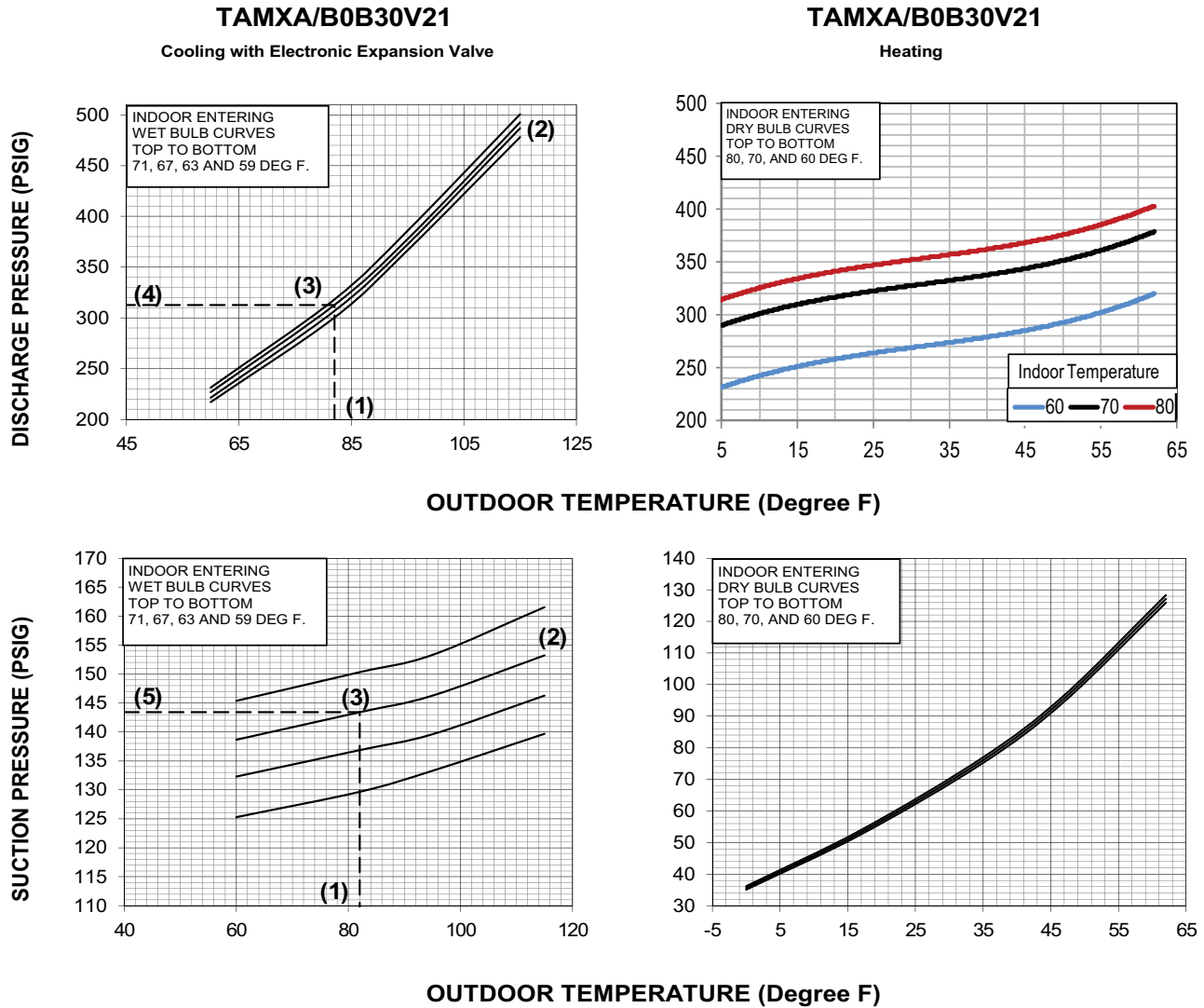

COOLING PERFORMANCE CAN BE CHECKED WHEN THE OUTDOOR TEMP IS ABOVE 55F.  
 \* WHEN USING PRESSURE CURVES TO VERIFY TYPICAL PERFORMANCE, ALWAYS RUN THE SYSTEM WITH ONE OF THE TEST MODES FOUND IN THE 950/850 COMFORT CONTROL. CHARGING MODE - COOLING OR CHECK CHARGE MODE - HEATING.  
 TO CHECK COOLING PERFORMANCE, SELECT THE PROPER INDOOR CFM, ALLOW PRESSURES TO STABILIZE. MEASURE INDOOR WET BULB TEMPERATURE, OUTDOOR TEMPERATURE, LIQUID AND SUCTION PRESSURES. ON THE PLOTS, LOCATE OUTDOOR TEMPERATURE (1); LOCATE INDOOR WET BULB (2); FIND INTERSECTION OF OD TEMP. & ID W.B. (3); READ DISCHARGE (4) OR SUCTION PRESSURE (5) IN LEFT COLUMN.

EXAMPLE: (1) OUTDOOR TEMP. 82 F.  
 (2) INDOOR WET BULB 67 F.  
 (3) AT INTERSECTION  
 (4) LIQUID PRESSURE @ 850 CFM IS 313 PSIG  
 (5) SUCTION PRESSURE @ 850 CFM IS 143 PSIG

ACTUAL:  
 LIQUID PRESSURE SHOULD BE +/- 10 PSI OF CHART  
 SUCTION PRESSURE SHOULD BE +/- 3 PSIG OF CHART

RATED INTERCONNECTING LINES  
 GAS - 5/8" O.D.  
 LIQUID - 3/8" O.D.

DWG. NO. 4A6V7X24A

Figure 14. 3 Ton HP (X36 Models)

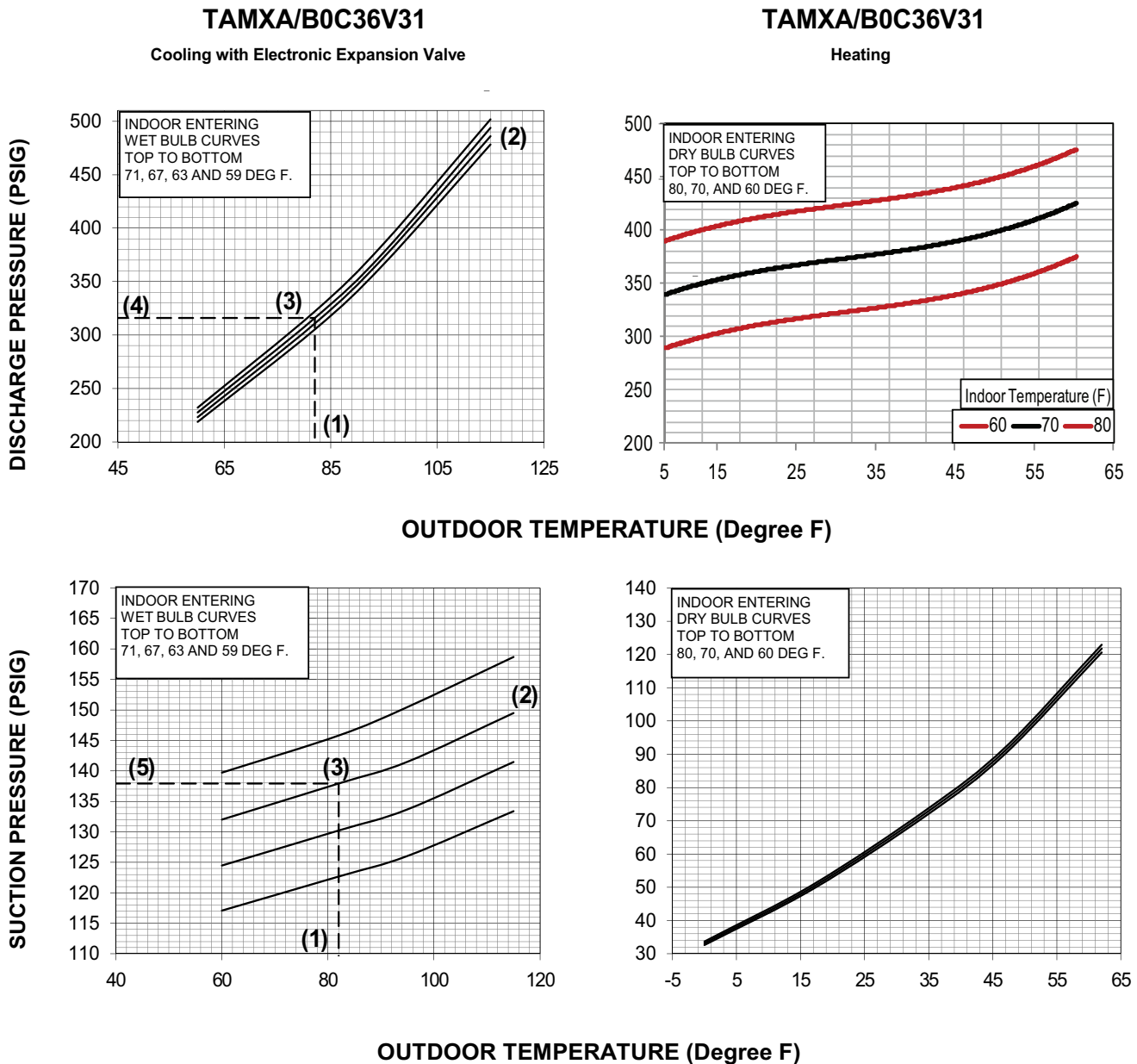

COOLING PERFORMANCE CAN BE CHECKED WHEN THE OUTDOOR TEMP IS ABOVE 55F.  
 \* WHEN USING PRESSURE CURVES TO VERIFY TYPICAL PERFORMANCE, ALWAYS RUN THE SYSTEM WITH ONE OF THE TEST MODES FOUND IN THE 950/850 COMFORT CONTROL. CHARGING MODE - COOLING OR CHECK CHARGE MODE - HEATING.  
 TO CHECK COOLING PERFORMANCE, SELECT THE PROPER INDOOR CFM, ALLOW PRESSURES TO STABILIZE. MEASURE INDOOR WET BULB TEMPERATURE, OUTDOOR TEMPERATURE, LIQUID AND SUCTION PRESSURES. ON THE PLOTS, LOCATE OUTDOOR TEMPERATURE (1); LOCATE INDOOR WET BULB (2); FIND INTERSECTION OF OD TEMP. & ID W.B. (3); READ DISCHARGE (4) OR SUCTION PRESSURE (5) IN LEFT COLUMN.

EXAMPLE: (1) OUTDOOR TEMP. 82 F.  
 (2) INDOOR WET BULB 67 F.  
 (3) AT INTERSECTION  
 (4) DISCHARGE PRESSURE @ 1400 CFM IS 316 PSIG  
 (5) SUCTION PRESSURE @ 1400 CFM IS 138 PSIG

ACTUAL:  
 LIQUID PRESSURE SHOULD BE +/- 10 PSI OF CHART  
 SUCTION PRESSURE SHOULD BE +/- 3 PSIG OF CHART

RATED INTERCONNECTING LINES  
 GAS - 3/4" O.D.  
 LIQUID - 3/8"

DWG. NO. 4A6V7X36A

Pressure Curves

Figure 15. 4 Ton HP (X48 Models)

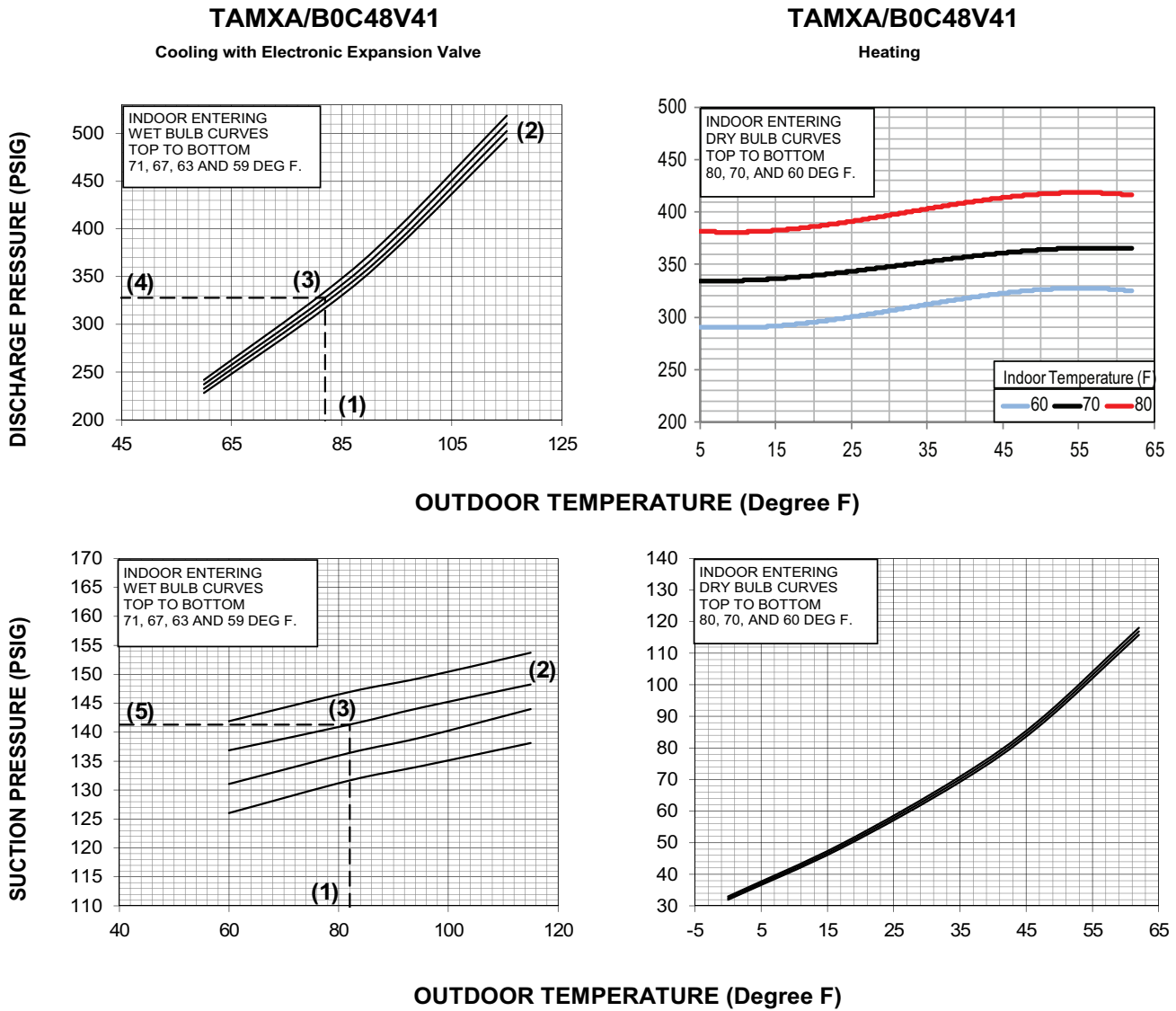

COOLING PERFORMANCE CAN BE CHECKED WHEN THE OUTDOOR TEMP IS ABOVE 55F.

\* WHEN USING PRESSURE CURVES TO VERIFY TYPICAL PERFORMANCE, ALWAYS RUN THE SYSTEM WITH ONE OF THE TEST MODES FOUND IN THE 950/850 COMFORT CONTROL. CHARGING MODE - COOLING OR CHECK CHARGE MODE - HEATING.

TO CHECK COOLING PERFORMANCE, SELECT THE PROPER INDOOR CFM, ALLOW PRESSURES TO STABILIZE. MEASURE INDOOR WET BULB TEMPERATURE, OUTDOOR TEMPERATURE, LIQUID AND SUCTION PRESSURES. ON THE PLOTS, LOCATE OUTDOOR TEMPERATURE (1); LOCATE INDOOR WET BULB (2); FIND INTERSECTION OF OD TEMP. & ID W.B. (3); READ DISCHARGE (4) OR SUCTION PRESSURE (5) IN LEFT COLUMN.

- EXAMPLE: (1) OUTDOOR TEMP. 82 F.  
 (2) INDOOR WET BULB 67 F.  
 (3) AT INTERSECTION  
 (4) DISCHARGE PRESSURE @ 1800 CFM IS 328 PSIG  
 (5) SUCTION PRESSURE @ 1800 CFM IS 141 PSIG

ACTUAL:  
 LIQUID PRESSURE SHOULD BE +/- 10 PSI OF CHART  
 SUCTION PRESSURE SHOULD BE +/- 3 PSIG OF CHART

RATED INTERCONNECTING LINES  
 GAS - 7/8" O.D.  
 LIQUID - 3/8"

DWG. NO. 4A6V7X48A

Figure 16. 5 Ton HP (X60 Models)

TAMXA/B0C60V51

Cooling with Electronic Expansion Valve

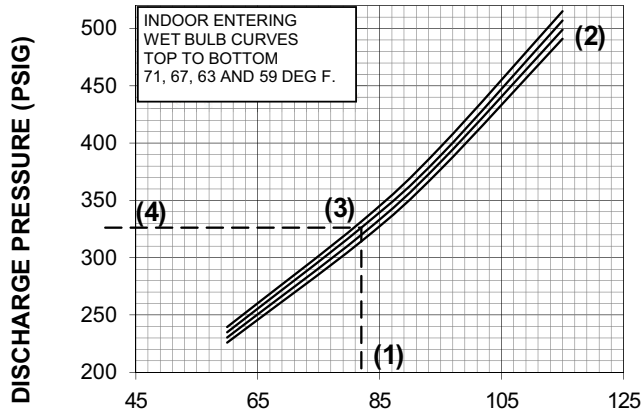

TAMXA/B0C60V51

Heating

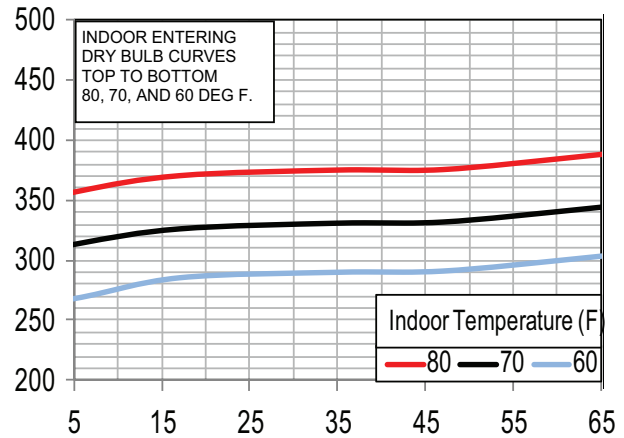

OUTDOOR TEMPERATURE (Degree F)

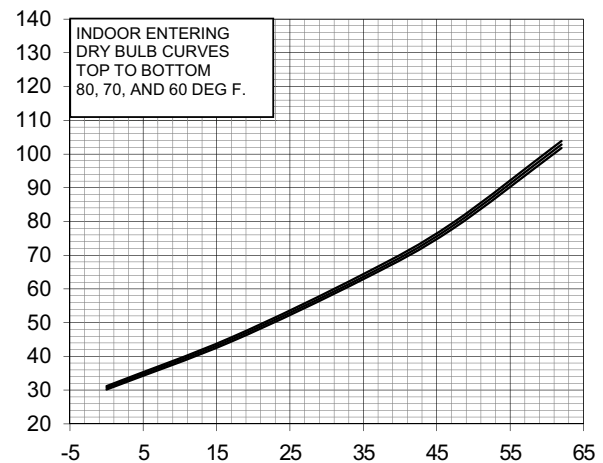
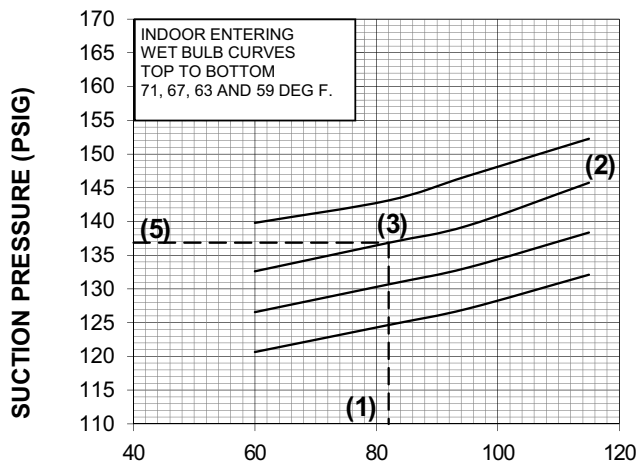

OUTDOOR TEMPERATURE (Degree F)

COOLING PERFORMANCE CAN BE CHECKED WHEN THE OUTDOOR TEMP IS ABOVE 55F.

\* WHEN USING PRESSURE CURVES TO VERIFY TYPICAL PERFORMANCE, ALWAYS RUN THE SYSTEM WITH ONE OF THE TEST MODES FOUND IN THE 950/850 COMFORT CONTROL. CHARGING MODE - COOLING OR CHECK CHARGE MODE - HEATING.

TO CHECK COOLING PERFORMANCE, SELECT THE PROPER INDOOR CFM, ALLOW PRESSURES TO STABILIZE. MEASURE INDOOR WET BULB TEMPERATURE, OUTDOOR TEMPERATURE, LIQUID AND SUCTION PRESSURES. ON THE PLOTS, LOCATE OUTDOOR TEMPERATURE (1); LOCATE INDOOR WET BULB (2); FIND INTERSECTION OF OD TEMP. & ID W.B. (3); READ LIQUID (4) OR SUCTION (5) PRESSURE IN LEFT COLUMN.

EXAMPLE: (1) OUTDOOR TEMP. 82 F.  
(2) INDOOR WET BULB 67 F.  
(3) AT INTERSECTION  
(4) LIQUID PRESSURE @ 2100 CFM IS 326 PSIG  
(5) SUCTION PRESSURE @ 2100 CFM IS 137 PSIG

ACTUAL:  
LIQUID PRESSURE SHOULD BE +/- 10 PSI OF CHART  
SUCTION PRESSURE SHOULD BE +/- 3 PSIG OF CHART

RATED INTERCONNECTING LINES  
GAS - 7/8" O.D.  
LIQUID - 3/8" O.D.

DWG. NO. 4A6V7X60A

**Pressure Curves**

**Figure 17. 2 Ton AC (X24 Models)**

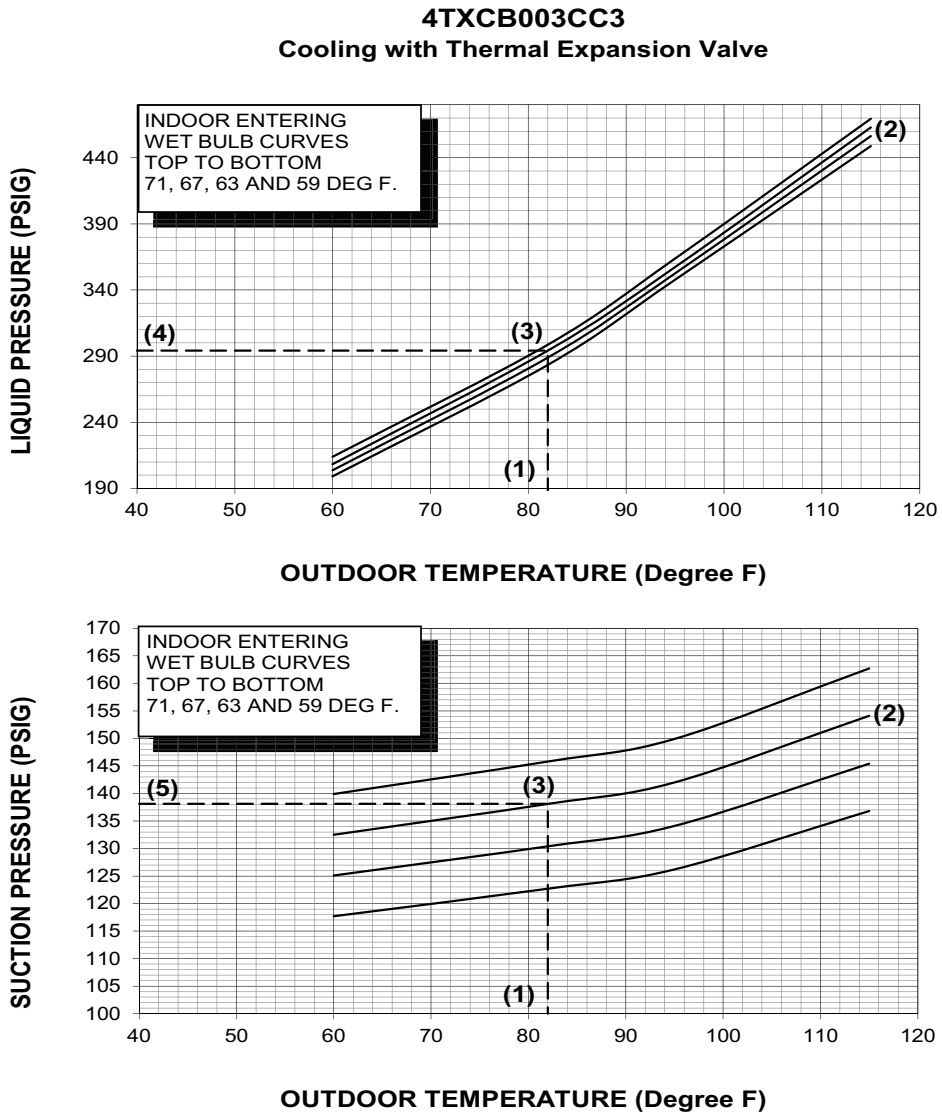

**COOLING PERFORMANCE CAN BE CHECKED WHEN THE OUTDOOR TEMP IS ABOVE 55F.**

\* WHEN USING PRESSURE CURVES TO VERIFY TYPICAL PERFORMANCE, ALWAYS RUN THE SYSTEM WITH ONE OF THE TEST MODES FOUND IN THE 950/850 COMFORT CONTROL. CHARGING MODE - COOLING.

TO CHECK COOLING PERFORMANCE, SELECT THE PROPER INDOOR CFM, ALLOW PRESSURES TO STABILIZE. MEASURE INDOOR WET BULB TEMPERATURE, OUTDOOR TEMPERATURE, LIQUID AND SUCTION PRESSURES. ON THE PLOTS, LOCATE OUTDOOR TEMPERATURE (1); LOCATE INDOOR WET BULB (2); FIND INTERSECTION OF OD TEMP. & ID W.B. (3); READ LIQUID (4) OR SUCTION (5) PRESSURE IN LEFT COLUMN.

EXAMPLE: (1) OUTDOOR TEMP. 82 F.  
(2) INDOOR WET BULB 67 F.  
(3) AT INTERSECTION  
(4) LIQUID PRESSURE @ 1070 CFM IS 294 PSIG  
(5) SUCTION PRESSURE @ 1070 CFM IS 138 PSIG

ACTUAL:  
LIQUID PRESSURE SHOULD BE +/- 10 PSI OF CHART  
SUCTION PRESSURE SHOULD BE +/- 3 PSIG OF CHART

**RATED INTERCONNECTING LINES**  
GAS - 5/8" O.D.  
LIQUID - 3/8"

DWG. NO. 4A7V7X24A



Figure 18. 3 Ton AC (X36 Models)

4TXCB004CC3HCB

Cooling with Thermal Expansion Valve

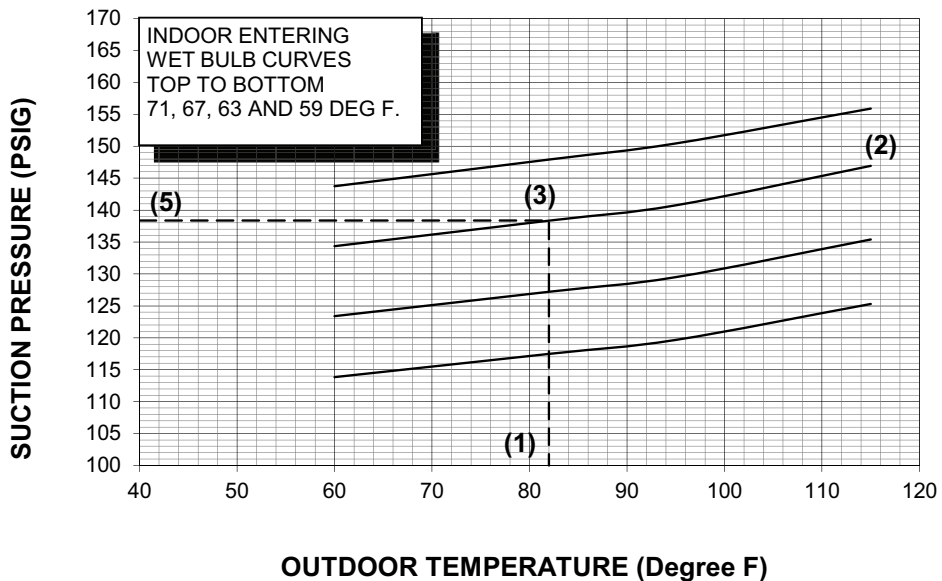
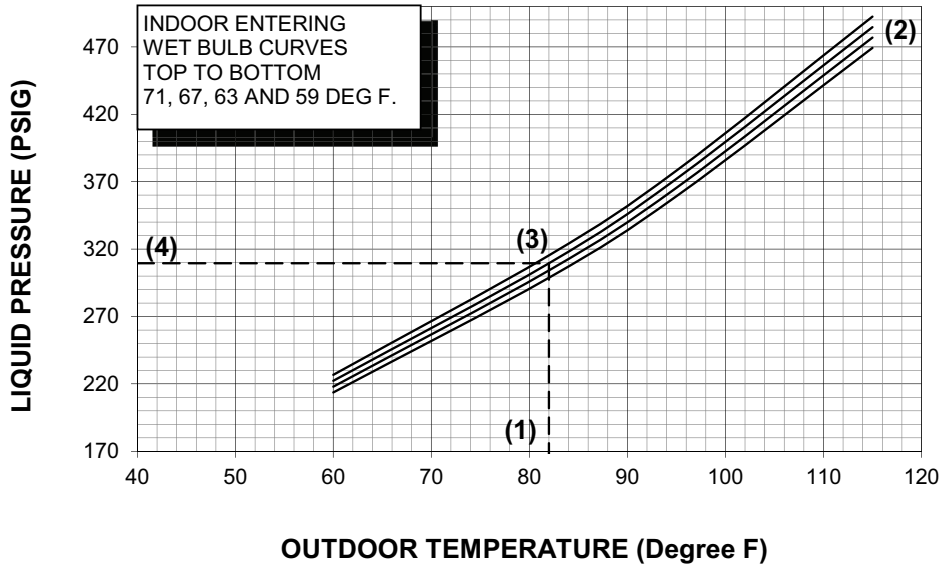

COOLING PERFORMANCE CAN BE CHECKED WHEN THE OUTDOOR TEMP IS ABOVE 55F.

\* WHEN USING PRESSURE CURVES TO VERIFY TYPICAL PERFORMANCE, ALWAYS RUN THE SYSTEM WITH ONE OF THE TEST MODES FOUND IN THE 950/850 COMFORT CONTROL. CHARGING MODE - COOLING.

TO CHECK COOLING PERFORMANCE, SELECT THE PROPER INDOOR CFM, ALLOW PRESSURES TO STABILIZE. MEASURE INDOOR WET BULB TEMPERATURE, OUTDOOR TEMPERATURE, LIQUID AND SUCTION PRESSURES. ON THE PLOTS, LOCATE OUTDOOR TEMPERATURE (1); LOCATE INDOOR WET BULB (2); FIND INTERSECTION OF OD TEMP. & ID W.B. (3); READ LIQUID (4) OR SUCTION (5) PRESSURE IN LEFT COLUMN.

- EXAMPLE: (1) OUTDOOR TEMP. 82 F.  
 (2) INDOOR WET BULB 67 F.  
 (3) AT INTERSECTION  
 (4) LIQUID PRESSURE @ 1050 CFM IS 310 PSIG  
 (5) SUCTION PRESSURE @ 1050 CFM IS 138 PSIG

ACTUAL:  
 LIQUID PRESSURE SHOULD BE +/- 10 PSI OF CHART  
 SUCTION PRESSURE SHOULD BE +/- 3 PSIG OF CHART

**RATED INTERCONNECTING LINES**  
 GAS - 3/4" O.D.  
 LIQUID - 3/8"

DWG. NO. 4A7V7X36A

**Pressure Curves**

**Figure 19. 4 Ton AC (X48 Models)  
TAMXA/B0C48V41  
Cooling with Electronic Expansion Valve**

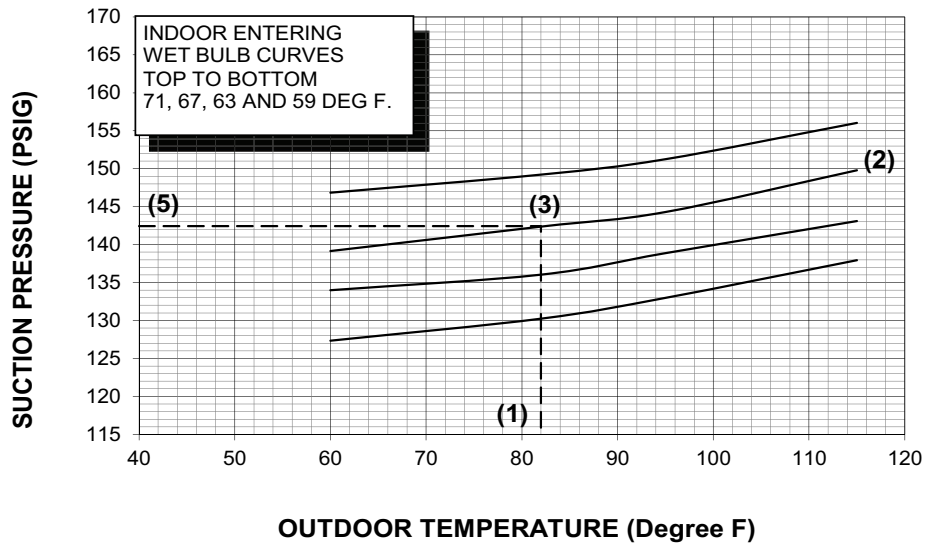
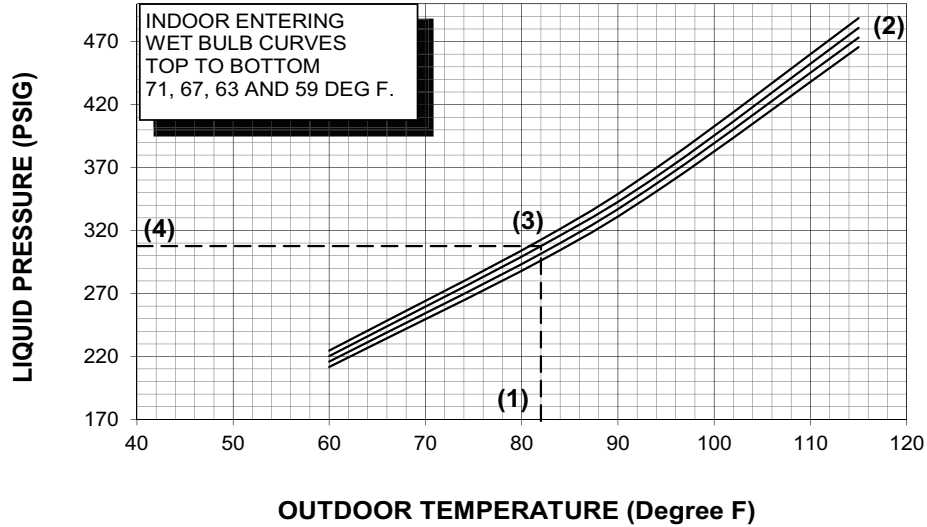

**COOLING PERFORMANCE CAN BE CHECKED WHEN THE OUTDOOR TEMP IS ABOVE 55F.**  
 \* WHEN USING PRESSURE CURVES TO VERIFY TYPICAL PERFORMANCE, ALWAYS RUN THE SYSTEM WITH ONE OF THE TEST MODES FOUND IN THE 950/850 COMFORT CONTROL. CHARGING MODE - COOLING.  
 TO CHECK COOLING PERFORMANCE, SELECT THE PROPER INDOOR CFM, ALLOW PRESSURES TO STABILIZE. MEASURE INDOOR WET BULB TEMPERATURE, OUTDOOR TEMPERATURE, LIQUID AND SUCTION PRESSURES. ON THE PLOTS, LOCATE OUTDOOR TEMPERATURE (1); LOCATE INDOOR WET BULB (2); FIND INTERSECTION OF OD TEMP. & ID W.B. (3); READ LIQUID (4) OR SUCTION (5) PRESSURE IN LEFT COLUMN.

EXAMPLE: (1) OUTDOOR TEMP. 82 F.  
 (2) INDOOR WET BULB 67 F.  
 (3) AT INTERSECTION  
 (4) LIQUID PRESSURE @ 1450 CFM IS 308 PSIG  
 (5) SUCTION PRESSURE @ 1450 CFM IS 142 PSIG

ACTUAL:  
 LIQUID PRESSURE SHOULD BE +/- 10 PSI OF CHART  
 SUCTION PRESSURE SHOULD BE +/- 3 PSIG OF CHART

**RATED INTERCONNECTING LINES**  
 GAS - 7/8" O.D.  
 LIQUID - 3/8"

DWG. NO. 4A7V7X48A

Figure 20. 5 Ton AC (X60 Models)  
TAMXA/B0C60V51  
Cooling with Electronic Expansion Valve

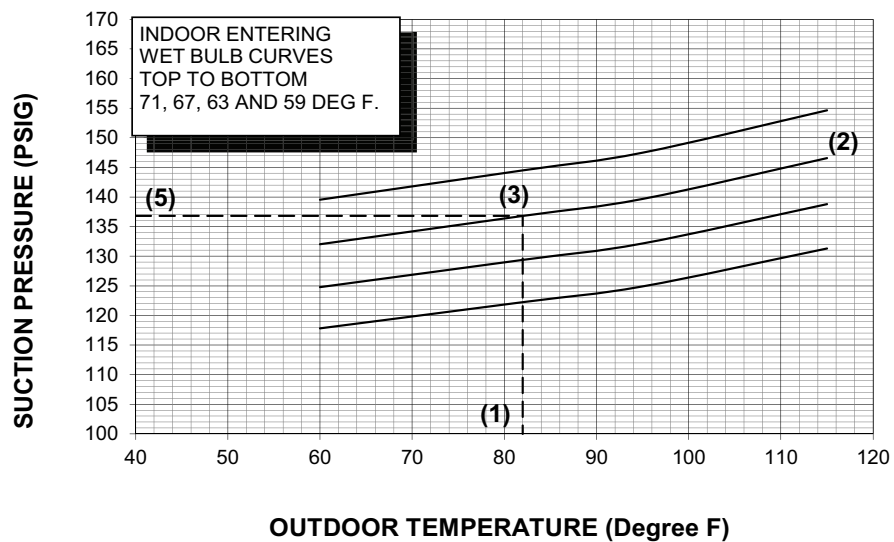
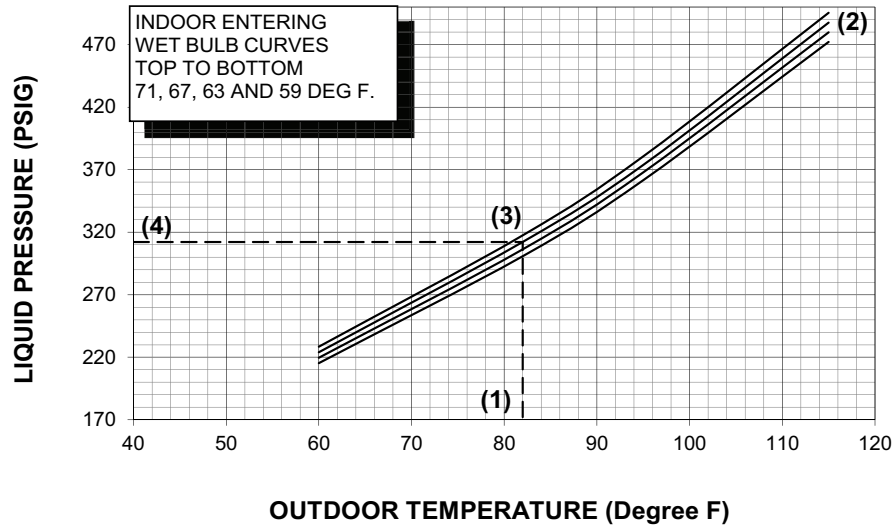

COOLING PERFORMANCE CAN BE CHECKED WHEN THE OUTDOOR TEMP IS ABOVE 55F.

\* WHEN USING PRESSURE CURVES TO VERIFY TYPICAL PERFORMANCE, ALWAYS RUN THE SYSTEM WITH ONE OF THE TEST MODES FOUND IN THE 950/850 COMFORT CONTROL. CHARGING MODE - COOLING.

TO CHECK COOLING PERFORMANCE, SELECT THE PROPER INDOOR CFM, ALLOW PRESSURES TO STABLIZE. MEASURE INDOOR WET BULB TEMPERATURE, OUTDOOR TEMPERATURE, LIQUID AND SUCTION PRESSURES. ON THE PLOTS, LOCATE OUTDOOR TEMPERATURE (1); LOCATE INDOOR WET BULB (2); FIND INTERSECTION OF OD TEMP. & ID W.B. (3); READ LIQUID (4) OR SUCTION (5) PRESSURE IN LEFT COLUMN.

EXAMPLE: (1) OUTDOOR TEMP. 82 F.  
(2) INDOOR WET BULB 67 F.  
(3) AT INTERSECTION  
(4) LIQUID PRESSURE @ 1450 CFM IS 312 PSIG  
(5) SUCTION PRESSURE @ 1450 CFM IS 137 PSIG

ACTUAL:  
LIQUID PRESSURE SHOULD BE +/- 10 PSI OF CHART  
SUCTION PRESSURE SHOULD BE +/- 3 PSIG OF CHART

RATED INTERCONNECTING LINES  
GAS - 1 - 1/8" O.D.  
LIQUID - 3/8"

DWG. NO. 4A7V7X60A

## Warranty Claim Process Integrated Variable Speed Control (Drive)

Servicing Dealers must obtain a pre-authorization number from a Field Service Representative (FSR) or a Factory Variable Speed Support Agent to obtain a warranty credit when replacing the Integrated Variable Speed Control Drive.

### Pre-Authorization Process

If the Drive is suspected to have failed, servicing technicians must follow all troubleshooting guidelines found in the Service Facts or Technical Manual. The local FSR should be contacted for additional diagnostic assistance and/or to obtain a pre-authorization number when a Drive failure has been confirmed. If the local FSR is not available, technicians should call the Factory Variable Speed Support Agent at 1-855-211-8900. This number can also be found inside the control box cover of the Variable Speed Outdoor Unit.

### Before a technician calls for pre-authorization:

- Record all alerts found on the UX360 User Interface and/or Diagnostic Mobile App.
- Record all Alerts reported to the UX360 User Interface and/or Diagnostic Mobile App.
- Run the drive diagnostic test found in the Service Sections of the Diagnostic Mobile App and/or UX360 User Interface.

### When a technician calls for pre-authorization from the job site:

- The FSR or Factory Variable Speed Support Agent will create a WMS ticket to log details of the diagnosis for the Drive warranty claim. The WMS ticket number will be provided to the technician.
- The technician should record and save the WMS ticket number. This will serve as the pre-authorization number.
- To file a warranty claim, the technician should provide the WMS pre-authorization number to the Parts Center agent when receiving the replacement Drive. If truck stock is used, provide the pre-authorization number with the returned Drive.
- The Parts Center representative will enter the pre-authorization number for warranty credit and give the technician a return invoice.
- The Falcon claim and WMS ticket will be cross referenced. If invalid, the claim will be reversed.
- All Drives are on Mandatory Return. Use the label provided on the replacement Drive packaging box to record the WMS pre-authorization number and return date.

## Notices

### FCC Notice

Contains FCC ID: WAP3025

*This device complies with part 15 of the FCC Rules. Operation is subject to the following two conditions: (1) This device may not cause harmful interference, and (2) this device must accept any interference received, including interference that may cause undesired operation. The antenna(s) used for this transmitter must be installed to provide a separation distance of at least 20 cm from all persons and must not be collocated or operating in conjunction with any other antenna or transmitter.*

*This equipment has been tested and found to comply with the limits for Class B Digital Device, pursuant to Part 15 of the FCC Rules. These limits are designed to provide reasonable protection against harmful interference in a residential installation. This equipment generates and can radiate radio frequency energy and, if not installed and used in accordance with the instructions, may cause harmful interference to radio communications. However, there is no guarantee that interference will not occur in a particular installation. If this equipment does cause harmful interference to radio or television reception, which can be determined by turning the equipment off and on, the user is encouraged to try to correct the interference by one or more of the following measures.*

- *Reorient or relocate the receiving antenna*
- *Increase the separation between the equipment and receiver*
- *Connect the equipment into an outlet on a circuit different from that to which the receiver is connected*
- *Consult the dealer or an experienced radio/TV technician for help*

*Any changes or modifications not expressly approved by the party responsible for compliance could void the user's authority to operate the equipment.*

### IC Notice

Contains IC ID: 7922A-3025

*This device complies with Industry Canada license exempt RSS standard(s). Operation is subject to the following two conditions: (1) this device may not cause interference, and (2) this device must accept any interference, including interference that may cause undesired operation of the device.*

*Le présent appareil est conforme aux CNR d'Industrie Canada applicables aux appareils radio exempts de licence. L'exploitation est autorisée aux deux conditions suivantes: (1) l'appareil de doit pas produire de brouillage, et (2) l'utilisateur de l'appareil doit accepter tout brouillage radioélectrique subi, même si le brouillage est susceptible d'en compromettre le fonctionnement.*





*American Standard*<sup>®</sup>  
HEATING & AIR CONDITIONING

About American Standard Heating and Air Conditioning  
American Standard has been creating comfortable and affordable living environments for more than a century. For more information, please visit [www.americanstandardair.com](http://www.americanstandardair.com).



The AHRI Certified mark indicates company participation in the AHRI Certification program. For verification of individual certified products, go to [ahridirectory.org](http://ahridirectory.org).

The manufacturer has a policy of continuous data improvement and it reserves the right to change design and specifications without notice. We are committed to using environmentally conscious print practices.